



WORKSPACE
SYSTEMS PTY LTD.



Workspace Systems Office Furniture Catalogue

VOL 17 2021

W: www.workspacesystems.com.au | Ph: 03 5153 1114 | E: info@workspacesystems.com.au

Address : 165 Macleod Street, Bairnsdale VIC 3875

CONTENTS

4-10	Reception and Lounge
11-15	Rapid Eternity 
16-21	Deluxe Rapid Infinity
22-27	Rapid Infinity
28-29	SHUSH30 
30-33	Rapid Screen
34-37	Rapid Span
38	Rapid Boost
39	Paramount
40	Height Adjustable Solutions
41	Monitor Arms
42-43	Softwiring
44-47	Tables
48-50	Rapid Worker
51-53	Rapid Vibe
54-56	Rapid Manager
57-71	Chairs
72	In House Upholstery
73	Hygiene & Health 
74-75	Presentation
76	Accessories
77	Personal Storage
78-79	Steel Storage
80	Mobile Storage
81-83	Lockers and Accessories

Your Rapidline product is delivered from distribution centres in Sydney, Melbourne, Brisbane and Perth, with a local customer service team in each location.

We not only deliver in these areas but also offer a full installation service.

Have a requirement for an office fitout?

Our in-house projects team can design any layout with Rapidline furniture specific to your requirements.

We cannot guarantee colours shown in this catalogue are the exact true representation of product colours. Specifications subject to change.





RECEPTION & LOUNGE

URBAN RECEPTION COUNTER - URC NW/DW

Dimensions :

Width	2200mm
Depth	800mm
Height	1150mm
Counter Height	750mm

Finish :



Features :

- Driftwood wrap around cowl feature panel
- Built in lockable 3 drawer under-desk pedestal
- Built in CPU & storage cupboard
- 2 x chrome cable entry hole covers

Certifications :



MARQUEE RECEPTION COUNTER - MRC GW/ZB

Dimensions :

Width	2400mm
Depth	835mm
Height	1150mm
Counter Height	750mm

Finish :



Features :

- Zebra veneer front columns
- Built in lockable 3 drawer under-desk pedestal
- Built in CPU & storage cupboard
- 2 x chrome cable entry hole covers with brush insulators

Certifications :



5-O RECEPTION COUNTER - RC5-O GW

Dimensions :

Width	2400mm
Depth	848mm
Height	1100mm
Counter Height	750mm

Finish :

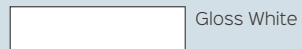

Features :

- Chrome trim detail on front panel
- Large work surface
- 2 x chrome cable entry hole covers with brush insulators
- E0 Melamine board

Certifications :



RC1809 RECEPTION COUNTER - RC1809 NW

Dimensions :

Width	1800mm
Depth	800mm
Height	1170mm
Counter Height	750mm

Finish :



Features :

- Black powdercoated perforated cowl
- Black matching kickplate
- E0 Melamine board

Certifications :



FLOW RECEPTION COUNTER - NCT1160

Dimensions :

Overall Width x Depth	2400 x 1600mm
Worksurface Depth	800mm
Height	1160mm
Counter Height	730mm

Finish :

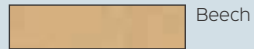

Features :

- Curved reception counter
- Glass feature on side
- High reception hob for privacy
- Can be used as Left or Right hand return

Certifications :



MODULAR RECEPTION COUNTER - MOD1NW | MOD2NW

MOD1NW · Full Height Module

Width	1339mm
Depth	800mm
Height	1160mm
Counter Height	730mm

MOD2NW · Glass Top Module

Width	1339mm
Depth	800mm
Height	935mm
Counter Height	730mm

Finish :



Certifications :



Features :

- Mix and match modular peices to suit your space
- E0 Melamine board



RAPID BLOOM VERTICAL GARDEN - SRBVG BK | SRBVG WH

Dimensions :

Width	395mm
Depth	210mm
Height	1940mm
Weight	34kg

Finish Options :

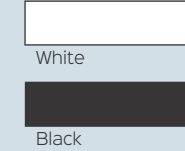

Features :

- 8 x 150mm diameter round pots
- 20kg of polished stones
- Wall & Floor mounting provisions
- *Plants not included

Certifications :



RECEPTION & LOUNGE

FLEXI MODULAR LOUNGE

SINGLE SEAT AND BACK REST - FL1

925mm W x 940mm D x 710mm H



TRIPLE SEAT AND BACK REST - FL2

1830mm W x 940mm D x 710mm H



Finish Options :

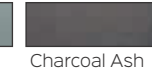

Certifications :



OTTOMAN - FLOTTO

480mm W x 480mm W x 430mm H



PILLOW - FLPL

550mm W x 400mm H



CUSHION - FLCU

400mm W x 400mm H



SINGLE BACK TO BACK - FL3

925mm W x 1880mm D x 710mm H



TRIPLE BACK TO BACK - FL4

1830mm W x 1880mm D x 710mm H



STRETCH - FL5

2755mm W x 940mm D x 710mm H

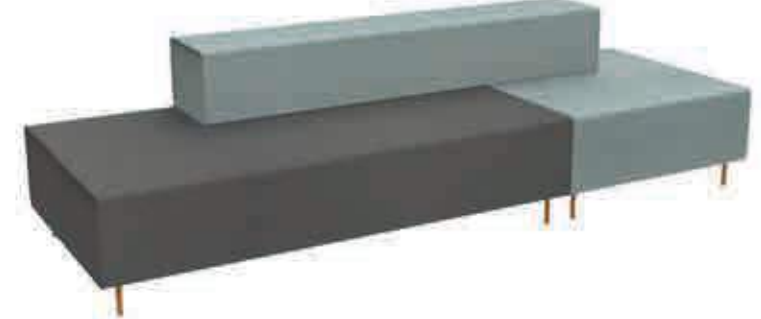

RETURN LOUNGE - FLRL

1245mm W x 585mm D x 430mm H



CORNER - FL6

2770mm W x 1830mm D x 710mm H



ISLAND - FL7

2755mm W x 1880mm D x 710mm H

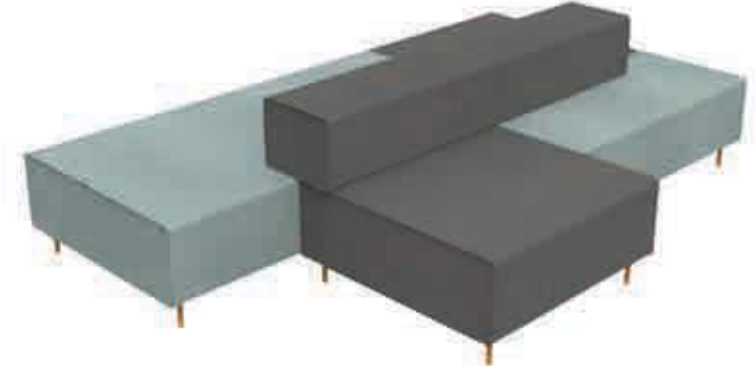

MARS ROUND OTTOMAN - MARS R

Dimensions :

Diameter	550mm
Height	450mm
Weight Rating	130kg

Features :

- Soft fabric upholstery
- Concealed black feet
- Match with square and triangle Mars ottomans

Finish Options :

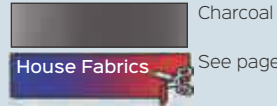

Certifications :



*Standard Charcoal



*Upholstered in Essence House Fabric

MARS SQUARE OTTOMAN - MARS S

Dimensions :

Width	550mm
Depth	550mm
Height	450mm
Weight Rating	130kg

Features :

- Soft fabric upholstery
- Concealed black feet
- Match with round and triangle Mars ottomans

Finish Options :

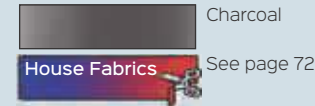

Certifications :



*Standard Charcoal



*Upholstered in Mist House Fabric

MARS TRIANGLE OTTOMAN - MARS T

Dimensions :

Overall Width	550mm
Overall Depth	485mm
Height	450mm
Weight Rating	130kg

Features :

- Soft fabric upholstery
- Concealed black feet
- Match with square and round Mars ottomans

Finish Options :

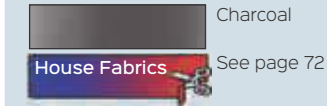

Certifications :



*Standard Charcoal



*Upholstered in Seafoam House Fabric

CONNECT 2 OTTOMAN - CONNECT2

Dimensions :

Diameter	320mm
Height	420mm
Weight Rating	110kg

Features :

- Steel underbase storage
- Upholstered seat cushion
- Can be upholstered in house fabrics

Finish Options :

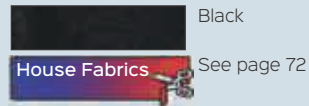

Certifications :



All ottomans available in an extended range of colours.

See page 72.



*Standard Black



*Upholstered in Steel House Fabric



ETERNITY SIDE TABLE - EST34

Dimensions :

Width	280mm
Depth	380mm
Height	600mm

Top Options :



Frame Options :

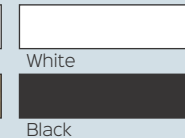

Features :

- Powdercoat Frame
- Slides under lounges
- Convenient surface

Certifications :



NEW

RECEPTION & LOUNGE

CARDINAL SINGLE LOUNGE - CSA

Dimensions :

Overall W x D x H	755 x 800 x 880mm
Seat W x D x H	450 x 480 x 450mm
Back W x H	700 x 530mm
Weight Rating	Up to 150kg

Finish Options :

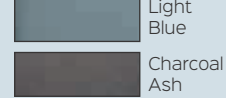

Certifications :



Features :

- Full fabric upholstery
- Removal seat & back cushion
- Powdercoated solid tube frame



CARDINAL TWO SEATER LOUNGE - CSA2

Dimensions :

Overall W x D x H	1335 x 800 x 880mm
Seat W x D x H	960 x 500 x 430mm
Back W x H	960 x 530mm
Weight Rating	Up to 200kg

Finish Options :

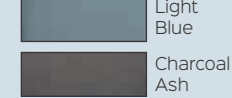

Certifications :



Features :

- Full fabric upholstery
- Removal seat & back cushion
- Powdercoated solid tube frame



CLOVER LOUNGE CHAIR - CLOVER CH

Dimensions :

Overall W x D x H	680 x 550 x 795mm
Seat W x D x H	530 x 460 x 445mm
Back W x H	520 x 400mm
Weight Rating	Up to 130kg

Finish :

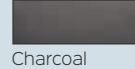

Certifications :



Features :

- Full fabric single lounge
- Stylish tapered back rest
- Angled cut arm rests



SPLASH CUBE SINGLE CHAIR - SPLASH CUBE

Dimensions :

Overall W x D x H	655 x 570 x 725mm
Seat W x D x H	460 x 520 x 500mm
Back W x H	460 x 330mm
Weight Rating	Up to 120kg

Finish Options :



Certifications :



Features :

- Contemporary style
- Cube shaped chair
- Stylish chrome sled base underframe



The reception area is so important.

It is the first contact with your customer, so create a welcoming, comfortable space with Rapidline furniture.

Make the right first impression.

SPACE TUB - SPTUB1

Dimensions :

Overall W x D x H	650 x 500 x 730mm
Seat W x D x H	540 x 430 x 446mm
Back Height	370mm
Weight Rating	Up to 120kg

Finish :

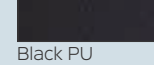

Certifications :



Features :

- Compact size
- Soft foam seat
- Polyurethane leather upholstery



SPACE EXECUTIVE TUB - SPEXEC TUB

Dimensions :

Overall W x D x H	600 x 600 x 770mm
Seat W x D x H	480 x 470 x 480mm
Back Height	390mm
Weight Rating	Up to 120kg

Finish :

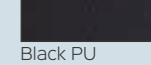

Certifications :



Features :

- Comfortable Larger Tub Seat
- Flared Arm Rest
- Stitching Detail on Back Rest



VENUS OTTOMAN - VENUS ST

Dimensions :

Width	1030mm
Depth	540mm
Height	410mm
Weight Rating	Up to 120kg

Finish :



Certifications :



Features :

- PU Finish for Easy Maintenance
- Button Stitching Detail
- Stainless Steel Frame



VENUS SINGLE LOUNGE SEAT - VENUS1

Dimensions :

Overall W x D x H	870 x 740 x 750mm
Seat W x D x H	630 x 500 x 420mm
Back W x D x H	630 x 110 x 400mm
Weight Rating	Up to 150kg

Finish :



Certifications :



Features :

- Button detail finish
- Black polyurethane leather
- Stainless steel frame



VENUS TWO SEATER LOUNGE - VENUS2

Dimensions :

Overall W x D x H	1370 x 740 x 750mm
Seat W x D x H	1120 x 500 x 420mm
Back W x D x H	1120 x 110 x 400mm
Weight Rating	Up to 200kg

Finish :

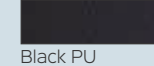

Certifications :



Features :

- Easy Maintenance
- Black polyurethane leather
- Stainless steel frame



VENUS THREE SEATER LOUNGE - VENUS3

Dimensions :

Overall W x D x H	2010 x 740 x 750mm
Seat W x D x H	1770 x 500 x 420mm
Back W x D x H	1170 x 110 x 400mm
Weight Rating	Up to 300kg

Finish :

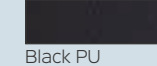

Certifications :



Features :

- Large three seater
- Black polyurethane leather
- Stainless steel frame



RECEPTION & LOUNGE

SINGLE LOUNGE SEAT - SPACE1

Dimensions :

Overall W x D x H	885 x 720 x 710mm
Seat W x D x H	550 x 515 x 445mm
Back W x D x H	570 x 120 x 310mm
Weight Rating	Up to 150kg

Finish :



Certifications :



Features :

- Soft, comfortable single lounge
- Black polyurethane leather finish
- Stylish chrome wrap around frame



TWO SEATER LOUNGE - SPACE2

Dimensions :

Overall W x D x H	1140 x 720 x 710mm
Seat W x D x H	1110 x 515 x 445mm
Back W x D x H	1110 x 120 x 310mm
Weight Rating	Up to 200kg

Finish :



Certifications :



Features :

- Available in 2 other matching sizes
- Two seater lounge
- Modern, comfortable seating



THREE SEATER LOUNGE - SPACE3

Dimensions :

Overall W x D x H	1960 x 720 x 710mm
Seat W x D x H	1670 x 515 x 445mm
Back W x D x H	1670 x 120 x 310mm
Weight Rating	Up to 300kg

Finish :

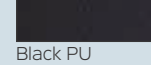

Certifications :



Features :

- Easy cleaning and maintenance
- Spacious 3 seater lounge



BUDGET COFFEE TABLE - CT96

Dimensions :

Table Top Width	900mm
Table Top Depth	600mm
Table Top Height	425mm

Finish :

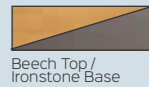

Certifications :



Features :

- Robust design with magazine shelf
- 25mm Melamine Beech top
- Melamine Ironstone base
- E0 Melamine board



GLASS COFFEE TABLE

Dimensions :

Table Top Width	• AGT66 - 600mm • AGT126 - 1200mm
Table Top Depth	600mm
Table Top Height	450mm

Finish :

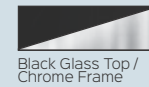

Certifications :



Features :

- Black glass and Chrome frame
- Available in two sizes
- Square or rectangular shape



ROUND COFFEE TABLE - CCT6

Dimensions :

Top Diameter	600mm
Overall Height	450mm
Frame Height	425mm

Top Finish :



Base Finish :

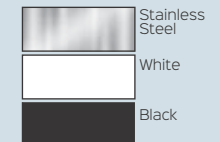

Features :

- Flat disc base
- Multiple colour choices
- Mix and match colours
- E0 Melamine board

Certifications :





RAPID ETERNITY - SINGLE SIDED

ETERNITY SINGLE SIDED WORKSTATIONS



D-ELS1P1575 NW / WS
1 Person | 1500mm
Natural White on White Satin



D-ELS1P1575 NO / BL
1 Person | 1500mm
Natural Oak on Black



D-ELS3P1575 NO / WS
3 Person | 1500mm per user
Natural Oak on White Satin

Create a space efficient workspace with Rapid Eternity, designed to maximise leg space, workstation strength and user communication.



Features :

- Stylish Eternity leg
- Maximise office space
- Large, medium or small desks
- 750mm Depth work top per user

Single Sided Workstation Options :

- Choose the number of persons required for your run of desks
- Choose between 1200mm, 1500mm or 1800mm desks
- Choose between black or white powdercoated frames and legs
- Choose between natural oak or natural white scalloped top

Dimensions :

*Overall Measurements

Product	Users	Width	Depth	Height
D-ELS1P1275	1	1200mm	750mm	730mm
D-ELS1P1575	1	1500mm	750mm	730mm
D-ELS1P1875	1	1800mm	750mm	730mm
D-ELS2P1275	2	2400mm	750mm	730mm
D-ELS2P1575	2	3000mm	750mm	730mm
D-ELS2P1875	2	3600mm	750mm	730mm
D-ELS3P1275	3	3600mm	750mm	730mm
D-ELS3P1575	3	4500mm	750mm	730mm
D-ELS3P1875	3	5400mm	750mm	730mm

Top Finishes :

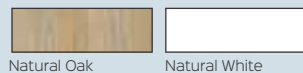

Leg and Frame Finishes :



Certifications :



ETERNITY SINGLE SIDED WORKSTATIONS WITH SCREENS



D-ELSW1P1575 NW / BL
1 Person | 1500mm
Natural White on Black



D-ELSW1P1575 NO / WS
1 Person | 1500mm
Natural Oak on White Satin



D-ELSW2P1575 NO / BL
2 Person | 1500mm per user
Natural Oak on Black

ETERNITY SINGLE SIDED WORKSTATIONS WITH SCREENS

Features :

- Stylish Eternity leg
- Maximise office space
- Large, medium or small desks
- 750mm Depth work top per user
- 730mm Desk height



Single Sided Workstations with Screens Options :

- Choose the number of persons required for your run of desks
- Choose between 1200mm, 1500mm or 1800mm desks
- Choose between black or white powdercoated frames and legs
- Choose between natural oak or natural white scalloped top
- Comes with 500mm high x 30mm thick fabric screens
- Choose between black fabric screen with white frame or grey fabric screen with black frame

Dimensions :

*Overall Measurements

Product	Users	Width	Depth	Height
D-ELSW1P1275	1	1200mm	780mm	1200mm
D-ELSW1P1575	1	1500mm	780mm	1200mm
D-ELSW1P1875	1	1800mm	780mm	1200mm
D-ELSW2P1275	2	2400mm	780mm	1200mm
D-ELSW2P1575	2	3000mm	780mm	1200mm
D-ELSW2P1875	2	3600mm	780mm	1200mm
D-ELSW3P1275	3	3600mm	780mm <td 1200mm	
D-ELSW3P1575	3	4500mm	780mm	1200mm
D-ELSW3P1875	3	5400mm	780mm	1200mm

Top Finishes :

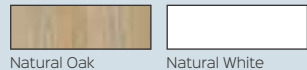

Natural Oak Natural White

Leg and Frame Finishes :



Black Powdercoat White Powdercoat

Screen Finishes :



Grey Fabric / Black Frame Black Fabric / White Frame



See page 72

Certifications :



ETERNITY SINGLE SIDED CORNER WORKSTATIONS



D-ELCWS1P1818 NW / BL
1 Person | 1800 x 1800mm
Natural White on Black



D-ELCWS1P1818 NO / WS
1 Person | 1800 x 1800mm
Natural Oak on White Satin



D-ELCWS1P1818 NO / BL
1 Person | 1800 x 1800mm
Natural Oak on Black

Features :

- Maximise office space
- Large, medium or small desks
- 750mm Depth work top per user
- Create a full matching suite with your Eternity desks



Single Corner Workstations Options :

- Choose between 1500 x 1500mm, 1800 x 1500mm or 1800 x 1800mm individual corner desks
- Choose black or white powdercoated frames and end legs
- Choose between natural oak or natural white top finishes
- All corner tops come with cable access hole

Dimensions :

*Overall Measurements

Product	Users	Width	Depth	Height
D-ELCWS1P151575	1	1500 x 1500mm	750mm	730mm
D-ELCWS1P181575	1	1800 x 1500mm	750mm	730mm
D-ELCWS1P181875	1	1800 x 1800mm	750mm	730mm

Top Finishes :

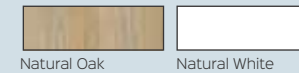

Natural Oak Natural White

Leg and Frame Finishes :



Black Powdercoat White Powdercoat

Certifications :



The Rapid Eternity Corner Workstation is a modular system that can suit any number of users required, with or without screens and accessories.

Matching round table and high bar table available.

Contact us today for more information.

RAPID ETERNITY - DOUBLE SIDED

ETERNITY DOUBLE SIDED WORKSTATIONS

Features :

- Stylish Eternity leg
- Maximise office space
- Large, medium or small desks
- 750mm Depth work top per user



Double Sided Workstations Options :

- Choose the number of persons required for your run of desks
- Choose 1200mm, 1500mm or 1800mm desks
- Choose black or white powdercoated frames and legs
- Choose natural oak or natural white scalloped top
- Choose to have optional infill rail to fill centre 30mm gap - see Infinity accessories page 23.

Dimensions :

*Overall Measurements

Product	Users	Width	Depth	Height
D-ELD2P1275	2	1200mm	1530mm	730mm
D-ELD2P1575	2	1500mm	1530mm	730mm
D-ELD2P1875	2	1800mm	1530mm	730mm
D-ELD4P1275	4	2400mm	1530mm	730mm
D-ELD4P1575	4	3000mm	1530mm	730mm
D-ELD4P1875	4	3600mm	1530mm	730mm
D-ELD6P1275	6	3600mm	1530mm	730mm
D-ELD6P1575	6	4500mm	1530mm	730mm
D-ELD6P1875	6	5400mm	1530mm	730mm

Top Finishes :

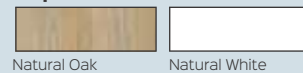

Leg and Frame Finishes :



Certifications :



The Rapid Eternity is a modular system that can suit any number of users required, contact us today for more information.

ETERNITY DOUBLE SIDED WORKSTATIONS WITH SCREENS



D-ELDWS2P1575 NO / WS
2 Person | 1500mm
Natural Oak on White Satin



D-ELDWS4P1575 NW / WS
4 Person | 1500mm
Natural White on White Satin



D-ELDWS6P1875 NO / BL
6 Person | 1800mm per user
Natural Oak on Black

ETERNITY DOUBLE SIDED WORKSTATIONS WITH SCREENS

Features :

- Stylish Eternity leg
- Maximise office space
- Large, medium or small desks
- 750mm Depth work top per user
- 730mm Desk height



Double Sided Workstations with Screens Options :

- Choose the number of persons required for your run of desks
- Choose between 1200mm, 1500mm or 1800mm desks
- Choose between black or white powdercoated frames and legs
- Choose between natural oak or natural white scalloped top
- Comes with 500mm high x 30mm thick fabric screens
- Choose between black fabric screen with white frame or grey fabric screen with black frame

Dimensions :

*Overall Measurements

Product	Users	Width	Depth	Height
D-ELDWS2P1275	2	1200mm	1530mm	1200mm
D-ELDWS2P1575	2	1500mm	1530mm	1200mm
D-ELDWS2P1875	2	1800mm	1530mm	1200mm
D-ELDWS4P1275	4	2400mm	1530mm	1200mm
D-ELDWS4P1575	4	3000mm	1530mm	1200mm
D-ELDWS4P1875	4	3600mm	1530mm	1200mm
D-ELDWS6P1275	6	3600mm	1530mm	1200mm
D-ELDWS6P1575	6	4500mm	1530mm	1200mm
D-ELDWS6P1875	6	5400mm	1530mm	1200mm

Top Finishes :



Natural Oak Natural White

Leg and Frame Finishes :



Black Powdercoat White Powdercoat

Screen Finishes :



Grey Fabric / Black Frame Black Fabric / White Frame

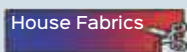

See page 72

Certifications :



ETERNITY 4-PERSON POD OF CORNER WORKSTATIONS WITH SCREENS

D-ELCWS4P1818 NO / WS

4 Person | 1800 x 1800mm per user | Natural Oak on White Satin



D-ELCWS4P1818 NW / BL

4 Person | 1800 x 1800mm per user | Natural White on Black



D-ELCWS4P1818 NO / BL

4 Person | 1800 x 1800mm per user | Natural Oak on Black



Features :

- Maximise office space
- Encourage team work
- 750mm Depth work top per user
- 3 workstation sizes available



4-Pod Corner Workstations with Screen Options :

- Choose between 1500 x 1500mm, 1800 x 1500mm or 1800 x 1800mm individual corner desk tops
- Choose between black or white powdercoated frames and legs
- Choose between natural oak or natural white scalloped top
- Comes with 500mm high x 30mm thick fabric screens
- Choose between black fabric screen with white frame or grey fabric screen with black frame

Dimensions :

*Overall Measurements

Product	Users	Width	Depth	Height
D-ELCWS4P151575	4	3000 x 3000mm	1500mm	1200mm
D-ELCWS4P181575	4	3600 x 3000mm	1500mm	1200mm
D-ELCWS4P181875	4	3600 x 3600mm	1500mm	1200mm

Top Finishes :



Natural Oak Natural White

Leg and Frame Finishes :

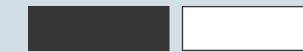

Black Powdercoat White Powdercoat

Screen Finishes :



Grey Fabric / Black Frame Black Fabric / White Frame



See page 72

Certifications :



DELUXE RAPID INFINITY



INFINITY SWING DOOR CUPBOARDS

Dimensions :

Options	<ul style="list-style-type: none"> IFSD96 - 2 Door - 900 x 600mm IFSD1245 - 3 Door - 1200 x 450mm IFSD1545 - 3 Door - 1500 x 450mm IFSD1845 - 4 Door - 1800 x 450mm
Height	730mm

Finish Options :

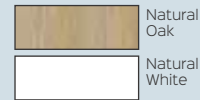

Features :

- Lockable - 2 keys supplied
- Shark nose feature on tops of doors
- Soft close hinges
- Adjustable levelling feet
- 18mm Thick E0 rated melamine board

Certifications :



INFINITY BOOKCASES

Dimensions :

Options	<ul style="list-style-type: none"> IFBK12 - 1200mm Height IFBK18 - 1800mm Height
Width	900mm
Depth	315mm

Finish Options :



Features :

- Adjustable shelves
- Black edging feature
- Aluminium tapered legs
- 25mm Thick Shelves, 18mm Sides
- E0 rated melamine board

Certifications :



DISC BASE TABLES - CBT

Dimensions :

Options	<ul style="list-style-type: none"> 900 x 900mm 900mm Diameter 1200mm Diameter
Height	755mm

Top Options :

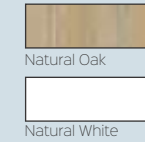

Base Options :



Features :

- E0 Melamine Board Tops
- Flush flat disc base
- Mix and match colours
- Mix and match sizes

Certifications :



ETERNITY MEETING TABLE

Dimensions :

Options	<ul style="list-style-type: none"> 900W x 900D 900mm Diameter 1200mm Diameter
Height	730mm

Top Options :

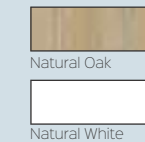

Base Options :

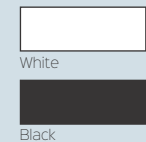

Features :

- Powdercoat base
- 25mm thick E0 Melamine top
- 2mm gauge steel construction
- Matches Eternity range

Certifications :



DELUXE RAPID INFINITY

DELUXE RAPID INFINITY SINGLE SIDED WORKSTATIONS

D-IPLS1P1875 NO / WS
Natural Oak, White Satin
Profile Leg
1 Person



D-ILLS2P1875 NW / BL
Natural White, Black
Loop Leg
2 Person



D-IPLS3P1875 NO / BL
Natural Oak, Black
Profile Leg
3 Person

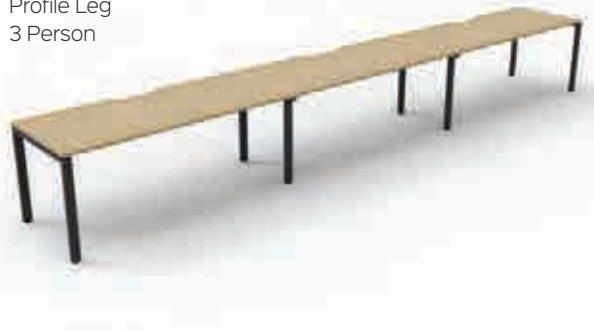

Create a space efficient workspace with Deluxe Rapid Infinity, designed to maximise leg space, workstation strength and user communication.



Single Sided Workstation Options

- Choose the number of persons required for your run of desks
- Choose from the Profile or Loop end leg styles
- Choose between 1200mm, 1500mm or 1800mm individual desk top widths x **750mm depth**
- Choose between black or white powdercoated frames and legs
- Choose between natural oak or natural white scalloped top

Top Finishes :



Natural Oak



Natural White

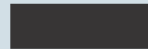

Black Powdercoat



White Powdercoat

Leg and Frame Finishes :

Profile Leg

*Overall Measurements

Product	Users	Width	Depth	Height
D-IPLS1P1275	1	1200mm	750mm	730mm
D-IPLS1P1575	1	1500mm	750mm	730mm
D-IPLS1P1875	1	1800mm	750mm	730mm
D-IPLS2P1275	2	2400mm	750mm	730mm
D-IPLS2P1575	2	3000mm	750mm	730mm
D-IPLS2P1875	2	3600mm	750mm	730mm
D-IPLS3P1275	3	3600mm	750mm	730mm
D-IPLS3P1575	3	4500mm	750mm	730mm
D-IPLS3P1875	3	5400mm	750mm	730mm

Loop Leg

D-ILLS1P1275	1	1200mm	750mm	730mm
D-ILLS1P1575	1	1500mm	750mm	730mm
D-ILLS1P1875	1	1800mm	750mm	730mm
D-ILLS2P1275	2	2400mm	750mm	730mm
D-ILLS2P1575	2	3000mm	750mm	730mm
D-ILLS2P1875	2	3600mm	750mm	730mm
D-ILLS3P1275	3	3600mm	750mm	730mm
D-ILLS3P1575	3	4500mm	750mm	730mm
D-ILLS3P1875	3	5400mm	750mm	730mm

SINGLE SIDED WORKSTATIONS WITH SCREENS

D-ILLSWS1P1875 NO / BL
Natural Oak, Black
Loop Leg
1 Person



D-IPLSWS2P1875 NO / WS
Natural Oak, White Satin
Profile Leg
2 Person



D-ILLSWS3P1875 NW / BL
Natural White, Black
Loop Leg
3 Person



SINGLE SIDED WORKSTATIONS WITH SCREENS

Single Sided Workstations with Screens Options

- Choose the number of persons required for your run of desks
- Choose from the Profile or Loop end leg styles
- Choose between 1200mm, 1500mm or 1800mm individual desk top widths x **750mm depth**
- Choose between black or white powdercoated frames and legs
- Choose between natural oak or natural white scalloped top
- Choose between black fabric screen with white frame or grey fabric screen with black frame
- Comes with 500mm high x 30mm thick fabric screen

Top Finishes :



Natural Oak



Natural White

Leg and Frame Finishes :

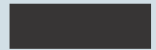

Black Powdercoat



White Powdercoat

Screen Finishes :



Grey Fabric /
Black Frame



Black Fabric /
White Frame

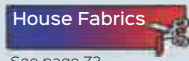

See page 72



Profile Leg

*Overall Measurements

Product	Users	Width	Depth	Height
D-IPLSWS1P1275	1	1200mm	780mm	1200mm
D-IPLSWS1P1575	1	1500mm	780mm	1200mm
D-IPLSWS1P1875	1	1800mm	780mm	1200mm
D-IPLSWS2P1275	2	2400mm	780mm	1200mm
D-IPLSWS2P1575	2	3000mm	780mm	1200mm
D-IPLSWS2P1875	2	3600mm	780mm	1200mm
D-IPLSWS3P1275	3	3600mm	780mm	1200mm
D-IPLSWS3P1575	3	4500mm	780mm	1200mm
D-IPLSWS3P1875	3	5400mm	780mm	1200mm

Loop Leg

D-ILLSWS1P1275	1	1200mm	780mm	1200mm
D-ILLSWS1P1575	1	1500mm	780mm	1200mm
D-ILLSWS1P1875	1	1800mm	780mm	1200mm
D-ILLSWS2P1275	2	2400mm	780mm	1200mm
D-ILLSWS2P1575	2	3000mm	780mm	1200mm
D-ILLSWS2P1875	2	3600mm	780mm	1200mm
D-ILLSWS3P1275	3	3600mm	780mm	1200mm
D-ILLSWS3P1575	3	4500mm	780mm	1200mm
D-ILLSWS3P1875	3	5400mm	780mm	1200mm

DELUXE RAPID INFINITY DOUBLE SIDED WORKSTATIONS

D-IPLD2P1875 NO / BL

Natural Oak, Black

Profile Leg

2 Person



D-ILLD4P1875 NW / BL

Natural White, Black

Loop Leg

4 Person



D-IPLD6P1875 NO / WS

Natural Oak, White Satin

Profile Leg

6 Person



Deluxe Rapid Infinity is a modular system that can suit any number of users required, contact us for more information.



Double Sided Workstation Options

- Choose the number of persons required for your double sided run of desks
- Choose from the Profile or Loop end leg styles
- Choose between 1200mm, 1500mm or 1800mm individual desk top widths x **750mm depth**
- Choose between black or white powdercoated frames and legs
- Choose between natural oak or natural white scalloped top
- Choose to have optional infill rail to fill centre gap - see Infinity accessories page. Or use as cable access gap

Top Finishes :



Natural Oak



Natural White

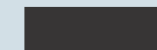

Black Powdercoat



White Powdercoat

Leg and Frame Finishes :

Profile Leg

*Overall Measurements

Product	Users	Width	Depth	Height
D-IPLD2P1275	2	1200mm	1530mm	730mm
D-IPLD2P1575	2	1500mm	1530mm	730mm
D-IPLD2P1875	2	1800mm	1530mm	730mm
D-IPLD4P1275	4	2400mm	1530mm	730mm
D-IPLD4P1575	4	3000mm	1530mm	730mm
D-IPLD4P1875	4	3600mm	1530mm	730mm
D-IPLD6P1275	6	3600mm	1530mm	730mm
D-IPLD6P1575	6	4500mm	1530mm	730mm
D-IPLD6P1875	6	5400mm	1530mm	730mm

Loop Leg

D-ILLD2P1275	2	1200mm	1530mm	730mm
D-ILLD2P1575	2	1500mm	1530mm	730mm
D-ILLD2P1875	2	1800mm	1530mm	730mm
D-ILLD4P1275	4	2400mm	1530mm	730mm
D-ILLD4P1575	4	3000mm	1530mm	730mm
D-ILLD4P1875	4	3600mm	1530mm	730mm
D-ILLD6P1275	6	3600mm	1530mm	730mm
D-ILLD6P1575	6	4500mm	1530mm	730mm
D-ILLD6P1875	6	5400mm	1530mm	730mm

DELUXE RAPID INFINITY DOUBLE SIDED WORKSTATIONS WITH SCREENS

D-IPLDWS2P1875 NO / WS
Natural Oak, White Satin
Profile Leg
2 Person



D-ILLDWS4P1875 NW / WS
Natural White, White Satin
Loop Leg
4 Person



D-IPLDWS6P1875 NO / BL
Natural Oak, Black
Profile Leg
6 Person



Double Sided Workstations with Screen Options

- Choose the number of persons required for your run of desks
- Choose from the Profile or Loop end leg styles
- Choose between 1200mm, 1500mm or 1800mm individual desk top widths x **750mm depth**
- Choose between black or white powdercoated frames and legs
- Choose between natural oak or natural white scalloped top
- Choose between black fabric screen with white frame or grey fabric screen with black frame
- Comes with 500mm high x 30mm thick fabric screen

Top Finishes

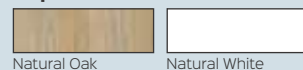

Natural Oak Natural White

Leg and Frame Finishes



Black Powdercoat White Powdercoat

Screen Finishes :



Grey Fabric / Black Frame Black Fabric / White Frame

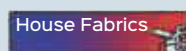

See page 72



Profile Leg

*Overall Measurements

Product	Users	Width	Depth	Height
D-IPLDWS2P1275	2	1200mm	1530mm	1200mm
D-IPLDWS2P1575	2	1500mm	1530mm	1200mm
D-IPLDWS2P1875	2	1800mm	1530mm	1200mm
D-IPLDWS4P1275	4	2400mm	1530mm	1200mm
D-IPLDWS4P1575	4	3000mm	1530mm	1200mm
D-IPLDWS4P1875	4	3600mm	1530mm	1200mm
D-IPLDWS6P1275	6	3600mm	1530mm	1200mm
D-IPLDWS6P1575	6	4500mm	1530mm	1200mm
D-IPLDWS6P1875	6	5400mm	1530mm	1200mm

Loop Leg

D-ILLDWS2P1275	2	1200mm	1530mm	1200mm
D-ILLDWS2P1575	2	1500mm	1530mm	1200mm
D-ILLDWS2P1875	2	1800mm	1530mm	1200mm
D-ILLDWS4P1275	4	2400mm	1530mm	1200mm
D-ILLDWS4P1575	4	3000mm	1530mm	1200mm
D-ILLDWS4P1875	4	3600mm	1530mm	1200mm
D-ILLDWS6P1275	6	3600mm	1530mm	1200mm
D-ILLDWS6P1575	6	4500mm	1530mm	1200mm
D-ILLDWS6P1875	6	5400mm	1530mm	1200mm

SINGLE CORNER WORKSTATION

D-ILLCWS1P181575 NW / BL
1800mm x 1500mm
Natural White, Black
Loop Leg
1 Person



D-IPLCWS1P181875 NO / WS
1800mm x 1800mm
Natural Oak, White
Profile Leg
1 Person



D-ILLCWS1P181875 NO / BL
1800mm x 1800mm
Natural Oak, Black
Loop Leg
1 Person



SINGLE CORNER WORKSTATION

Single Corner Workstation Options

- Choose from the Profile or Loop end leg styles
- Choose between 1500 x 1500mm, 1800 x 1500mm or 1800 x 1800mm individual corner desk top widths x **750mm depth**
- Choose between black or white powdercoated frames and end legs
- Choose between natural oak or natural white top finishes
- All corner tops come with cable access hole

Top Finishes :

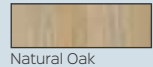

Natural Oak



Natural White

Leg and Frame Finishes :

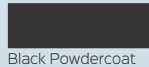

Black Powdercoat

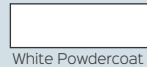

White Powdercoat

Profile Leg

*Overall Measurements

Product Code	Users	Width	Depth	Height
D-IPLCWS1P151575	1	1500 x 1500mm	750mm	730mm
D-IPLCWS1P181575	1	1800 x 1500mm	750mm	730mm
D-IPLCWS1P181875	1	1800 x 1800mm	750mm	730mm

Loop Leg

Product Code	Users	Width	Depth	Height
D-ILLCWS1P151575	1	1500 x 1500mm	750mm	730mm
D-ILLCWS1P181575	1	1800 x 1500mm	750mm	730mm
D-ILLCWS1P181875	1	1800 x 1800mm	750mm	730mm

The Deluxe Rapid Infinity Corner Workstation is a modular system that can suit any number of users required, with or without screens and accessories.

Contact us today for more information.



4-PERSON POD OF CORNER WORKSTATIONS WITH SCREENS

D-ILLCWS4PWS181575 NO / WS

Natural Oak, White Satin

Loop Leg

4 Person



D-IPLCWS4PWS181875 NW / BL

Natural White, Black

Profile Leg

4 Person



D-ILLCWS4PWS181875 NO / BL

Natural Oak, Black

Loop Leg

4 Person



4-Person Corner Workstation Pod With Screen Options

- Choose from the Profile or Loop end leg
- Choose from 1500 x 1500mm, 1800 x 1500mm or 1800 x 1800mm individual corner desk top widths x **750mm depth**
- Choose between natural oak or natural white top finishes
- Choose between black or white powdercoated frames and legs
- Choose between black fabric screen with white frame or grey fabric screen with black frame.
- Fabric screen is 500mm high x 30mm thick

Top Finishes



Natural Oak



Natural White

Leg and Frame Finishes

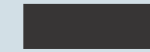

Black Powdercoat



White Powdercoat

Screen Finishes



Grey Fabric / Black Frame



Black Fabric / White Frame

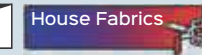

See page 72



Profile Leg

*Overall Measurements

Product Code	Users	Width	Depth	Height
D-IPLCWS4P151575	4	3000 x 3000mm	1500mm	1200mm
D-IPLCWS4P181575	4	3600 x 3000mm	1500mm	1200mm
D-IPLCWS4P181875	4	3600 x 3600mm	1500mm	1200mm

Loop Leg

D-ILLCWS4P151575	4	3000 x 3000mm	1500mm	1200mm
D-ILLCWS4P181575	4	3600 x 3000mm	1500mm	1200mm
D-ILLCWS4P181875	4	3600 x 3600mm	1500mm	1200mm

Why Choose Deluxe Infinity?

- Black or white leg options
- 750mm deep work top for more space
- Natural white or natural oak top finish options
- Scalloped cable access for straight work tops
- Grey screen available with black frame



INFINITY CENTRE SCREEN

Dimensions :

Width	IS1200 - 1200mm
Options	IS1500 - 1500mm IS1800 - 1800mm
Height	500mm
Thickness	30mm

Finish Options :

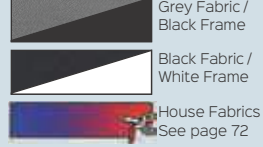

Features :

- Pinnable fabric
- Black or White frame colour finishes
- Matches Deluxe and Infinity ranges

Certifications :

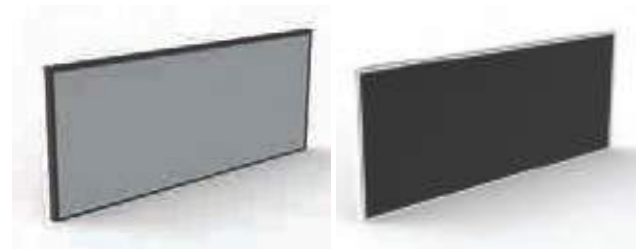

INFINITY RETURN DIVIDER - IS700

Dimensions :

Width	690mm
Height	350mm
Thickness	20mm

Finish Options :



Features :

- Return dividing screens
- Desk mounted screw fixings
- Adds privacy between users
- Matches Deluxe and Infinity ranges

Certifications :



INFINITY INFILL PANEL

Dimensions :

Width	D-IF12 - 1200mm
Options	D-IF12 - 1500mm D-IF12 - 1800mm
Depth	30mm
Height	30mm

Finish Options :



Features :

- Fills 30mm gap between double sided back to back Deluxe and Infinity workstation ranges

Certifications :



INFINITY DESK MOUNTED SHELF - DMSHELF

Dimensions :

Width	600mm
Depth	300mm
Overall Height	450mm
Desk Top to Shelf Height	208mm

Finish Options :

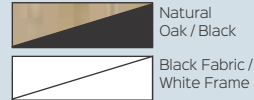

Features :

- 25mm thick E0 rated enviroboard
- Comes with 4 x wire dividers

Certifications :



INFINITY SCREEN HUNG SHELF - ISHELF600

Dimensions :

Width	600mm
Depth	270mm
Height	250mm

Finish Options :

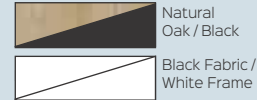

Features :

- 18mm thick E0 rated enviroboard
- Powdercoated steel shelf brackets
- Available in 2 finishes
- Hangs from infinity centre screens

Certifications :



ETERNITY SLIMLINE MOBILE PEDESTAL - EMP3 WB

Dimensions :

Width	300mm
Depth	535mm
Height	580mm

Finish Options :



Features :

- Powdercoated steel
- Slimline mobile pedestal
- 2 personal drawers and 1 file drawer
- Fifth wheel for stability and anti-tilt

Certifications :



RAPID INFINITY SINGLE SIDED WORKSTATIONS

IPLS1P187ST NW
Scalloped Edge Top
Profile Leg
1 Person



IPLS2P187 B
Cable Entry Holes
Profile Leg
2 Person



ILLS3P187 NW
Cable Entry Holes
Loop Leg
3 Person



Create a space efficient workspace with Rapid Infinity, designed to maximise leg space, workstation strength and user communication.

Single Sided Workstation Options

- Choose the number of persons required for your run of desks
- Choose from the Profile or Loop end leg styles
- Choose between 1200mm, 1500mm or 1800mm individual desks
- Choose between natural white with cable entry holes, beech with cable entry holes or natural white scalloped top finishes

Top Finish Options :

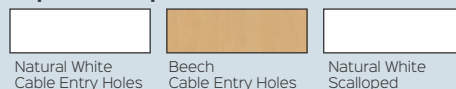

Frame Finish :

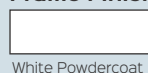

White Powdercoat



Profile Leg

*Overall Measurements

Product	Users	Width	Depth	Height
IPLS1P127	1	1200mm	700mm	730mm
IPLS1P157	1	1500mm	700mm	730mm
IPLS1P187	1	1800mm	700mm	730mm
IPLS2P127	2	2400mm	700mm	730mm
IPLS2P157	2	3000mm	700mm	730mm
IPLS2P187	2	3600mm	700mm	730mm
IPLS3P127	3	3600mm	700mm	730mm
IPLS3P157	3	4500mm	700mm	730mm
IPLS3P187	3	5400mm	700mm	730mm

Loop Leg

ILLS1P127	1	1200mm	700mm	730mm
ILLS1P157	1	1500mm	700mm	730mm
ILLS1P187	1	1800mm	700mm	730mm
ILLS2P127	2	2400mm	700mm	730mm
ILLS2P157	2	3000mm	700mm	730mm
ILLS2P187	2	3600mm	700mm	730mm
ILLS3P127	3	3600mm	700mm	730mm
ILLS3P157	3	4500mm	700mm	730mm
ILLS3P187	3	5400mm	700mm	730mm

SINGLE SIDED WORKSTATIONS WITH SCREENS

ILLSWS1P187 NW
Cable Entry Holes
Loop Leg
1 Person



IPLSWS2P187 B
Cable Entry Holes
Profile Leg
2 Person



IPLSWS3P187ST NW
Scalloped Edge Top
Profile Leg
3 Person

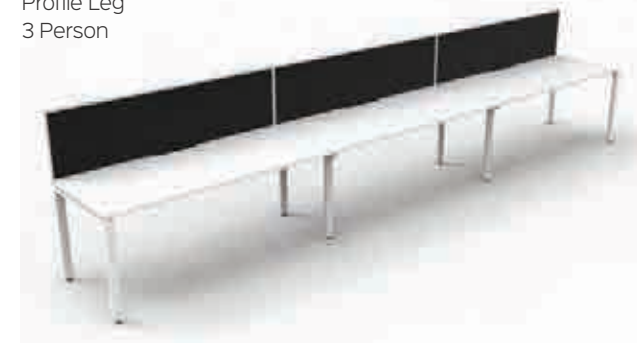

SINGLE SIDED WORKSTATIONS WITH SCREENS

Single Sided Workstations with Screen Options

- Choose the number of persons required for your run of desks
- Choose from the Profile or Loop end leg styles
- Choose between 1200mm, 1500mm or 1800mm individual desks
- Choose between natural white with cable entry holes, beech with cable entry holes or natural white scalloped top finishes
- Comes with 500mm high x 30mm thick black fabric screen
- 700mm Top Depth

Top Finish Options :

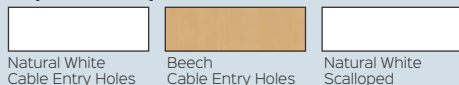

Natural White
Cable Entry Holes

Beech
Cable Entry Holes

Natural White
Scalloped



Frame Finish :



White
Powdercoat

Screen Finish :



Black Fabric /
White Frame



See page 72



Profile Leg

*Overall Measurements

Product	Users	Width	Depth	Height
IPLSWS1P127	1	1200mm	730mm	1200mm
IPLSWS1P157	1	1500mm	730mm	1200mm
IPLSWS1P187	1	1800mm	730mm	1200mm
IPLSWS2P127	2	2400mm	730mm	1200mm
IPLSWS2P157	2	3000mm	730mm	1200mm
IPLSWS2P187	2	3600mm	730mm	1200mm
IPLSWS3P127	3	3600mm	730mm	1200mm
IPLSWS3P157	3	4500mm	730mm	1200mm
IPLSWS3P187	3	5400mm	730mm	1200mm

Loop Leg

ILLSWS1P127	1	1200mm	730mm	1200mm
ILLSWS1P157	1	1500mm	730mm	1200mm
ILLSWS1P187	1	1800mm	730mm	1200mm
ILLSWS2P127	2	2400mm	730mm	1200mm
ILLSWS2P157	2	3000mm	730mm	1200mm
ILLSWS2P187	2	3600mm	730mm	1200mm
ILLSWS3P127	3	3600mm	730mm	1200mm
ILLSWS3P157	3	4500mm	730mm	1200mm
ILLSWS3P187	3	5400mm	730mm	1200mm

RAPID INFINITY DOUBLE SIDED WORKSTATIONS

IPLD2P187ST NW

Scalloped Edge Top

Profile Leg

2 Person



ILLD4P187 B

Cable Entry Holes

Loop Leg

4 Person



ILLD6P187 NW

Cable Entry Holes

Loop Leg

6 Person



Double Sided Workstation Options

- Choose the number of persons required for your run of desks
- Choose from the Profile or Loop end leg styles
- Choose between 1200mm, 1500mm or 1800mm individual desks
- Choose between natural white with cable entry holes, beech with cable entry holes or natural white scalloped top finishes
- Choose to have optional infill rail to fill centre gap - see Infinity accessories page

Top Finish Options :

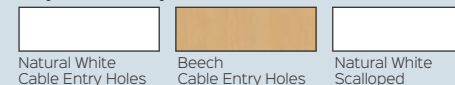

Natural White
Cable Entry Holes

Beech
Cable Entry Holes

Natural White
Scalloped

Frame Finish :



White
Powdercoat



Profile Leg

*Overall Measurements

Product	Users	Width	Depth	Height
IPLD2P127	2	1200mm	1430mm	730mm
IPLD2P157	2	1500mm	1430mm	730mm
IPLD2P187	2	1800mm	1430mm	730mm
IPLD4P127	4	2400mm	1430mm	730mm
IPLD4P157	4	3000mm	1430mm	730mm
IPLD4P187	4	3600mm	1430mm	730mm
IPLD6P127	6	3600mm	1430mm	730mm
IPLD6P157	6	4500mm	1430mm	730mm
IPLD6P187	6	5400mm	1430mm	730mm

Loop Leg

ILLD2P127	2	1200mm	1430mm	730mm
ILLD2P157	2	1500mm	1430mm	730mm
ILLD2P187	2	1800mm	1430mm	730mm
ILLD4P127	4	2400mm	1430mm	730mm
ILLD4P157	4	3000mm	1430mm	730mm
ILLD4P187	4	3600mm	1430mm	730mm
ILLD6P127	6	3600mm	1430mm	730mm
ILLD6P157	6	4500mm	1430mm	730mm
ILLD6P187	6	5400mm	1430mm	730mm

DOUBLE SIDED WORKSTATIONS WITH SCREENS

ILLDWS2P187 NW

Cable Entry Holes
Loop Leg
2 Person



IPLDWS4P187 B

Cable Entry Holes
Profile Leg
4 Person



ILLDWS6P187ST NW

Scalloped Edge Top
Loop Leg
6 Person

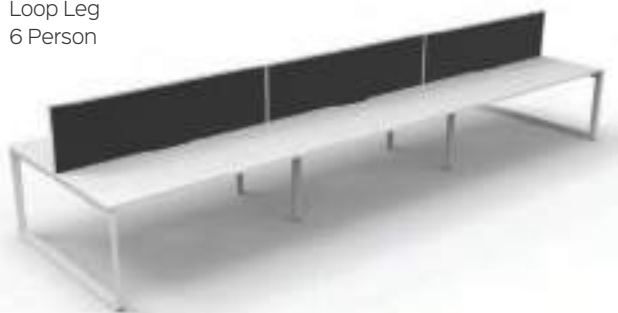

Double Sided Workstations with Screens Options

- Choose the number of persons required for your run of desks
- Choose from the Profile or Loop end leg styles
- Choose between 1200mm, 1500mm or 1800mm individual desks
- Choose between natural white with cable entry holes, beech with cable entry holes or natural white scalloped top finishes
- Comes with 500mm high x 30mm thick black fabric screen

Top Finish Options :

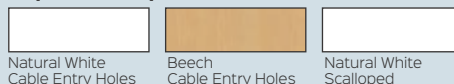

Natural White
Cable Entry Holes

Beech
Cable Entry Holes

Natural White
Scalloped



Frame Finish :



White
Powdercoat

Screen Finish :



Black Fabric /
White Frame



See page 72



Profile Leg

*Overall Measurements

Product	Users	Width	Depth	Height
IPLDWS2P127	2	1200mm	1430mm	1200mm
IPLDWS2P157	2	1500mm	1430mm	1200mm
IPLDWS2P187	2	1800mm	1430mm	1200mm
IPLDWS4P127	4	2400mm	1430mm	1200mm
IPLDWS4P157	4	3000mm	1430mm	1200mm
IPLDWS4P187	4	3600mm	1430mm	1200mm
IPLDWS6P127	6	3600mm	1430mm	1200mm
IPLDWS6P157	6	4500mm	1430mm	1200mm
IPLDWS6P187	6	5400mm	1430mm	1200mm

Loop Leg

ILLDWS2P127	2	1200mm	1430mm	1200mm
ILLDWS2P157	2	1500mm	1430mm	1200mm
ILLDWS2P187	2	1800mm	1430mm	1200mm
ILLDWS4P127	4	2400mm	1430mm	1200mm
ILLDWS4P157	4	3000mm	1430mm	1200mm
ILLDWS4P187	4	3600mm	1430mm	1200mm
ILLDWS6P127	6	3600mm	1430mm	1200mm
ILLDWS6P157	6	4500mm	1430mm	1200mm
ILLDWS6P187	6	5400mm	1430mm	1200mm

SINGLE CORNER WORKSTATION

IPLCWS1P1815 NW

1800mm x 1500mm
Cable Entry Hole
Profile Leg
1 Person



ILLCWS1P1818 B

1800mm x 1800mm
Cable Entry Hole
Loop Leg
1 Person



IPLCWS1P1818 NW

1800mm x 1800mm
Cable Entry Hole
Profile Leg
1 Person



SINGLE CORNER WORKSTATION

Single Corner Workstation Options

- Choose from the Profile or Loop end leg styles
- Choose between 1500mm x 1500mm, 1800mm x 1500mm or 1800mm x 1800mm individual corner desks x 700mm depth
- Choose between natural white top with a single cable entry hole or beech top with a single cable entry hole

Top Finish Options :



Frame Finish

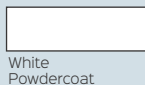

Profile Leg

*Overall Measurements

Product	Users	Width	Depth	Height
IPLCWS1P15157	1	1500x 1500mm	700mm	730mm
IPLCWS1P18157	1	1800x 1500mm	700mm	730mm
IPLCWS1P18187	1	1800x 1800mm	700mm	730mm

Loop Leg

Product Code	Users	Width	Depth	Height
ILLCWS1P15157	1	1500x 1500mm	700mm	730mm
ILLCWS1P18157	1	1800x 1500mm	700mm	730mm
ILLCWS1P18187	1	1800x 1800mm	700mm	730mm

The Rapid Infinity Corner Workstation is a modular system that can suit any number of users required, with or without screens and accessories.

Contact us today for more information.

4-PERSON POD OF CORNER WORKSTATIONS WITH SCREENS

ILLCWS4PWS1815 NW

1800mm x 1500mm

Loop Leg

4 Person

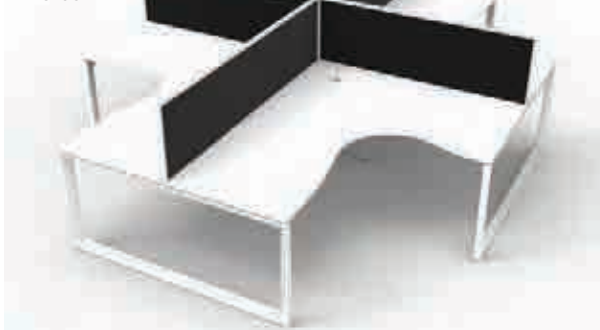

IPLCWS4PWS1818 B

1800mm x 1800mm

Profile Leg

4 Person



ILLCWS4PWS1818 NW

1800mm x 1800mm

Loop Leg

4 Person

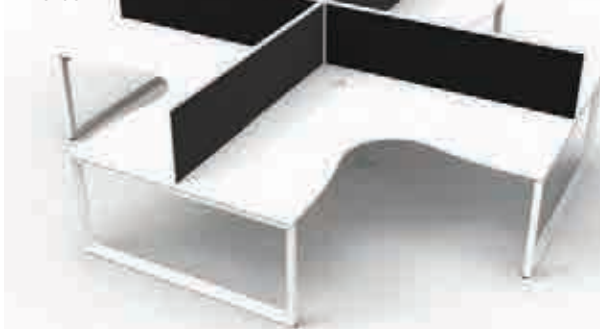

4-Person Corner Workstation Pod With Screens Options

- Choose from the Profile or Loop end leg styles
- Choose between 1500mm x 1500mm, 1800mm x 1500mm or 1800mm x 1800mm individual corner desks x 700mm depth
- Choose between natural white top with a single cable entry hole or beech top with a single cable entry hole
- Comes with 500mm high x 30mm thick black fabric screen

Top Finish Options :



Frame Finish :

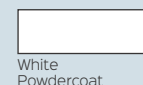

Screen Finish :



Profile Leg

*Overall Measurements

Product	Users	Width	Depth	Height
IPLCWS4P15157	4	3000x 3000mm	1430mm	1200mm
IPLCWS4P18157	4	3600x 3000mm	1430mm	1200mm
IPLCWS4P18187	4	3600x 3600mm	1430mm	1200mm

Loop Leg

ILLCWS4P15157	4	3000x 3000mm	1430mm	1200mm
ILLCWS4P18157	4	3600x 3000mm	1430mm	1200mm
ILLCWS4P18187	4	3600x 3600mm	1430mm	1200mm

Why Choose Rapid Infinity?

- Simple, clean white legs and frames
- 700mm deep work top for tighter offices
- Natural white or beech top finish options
- Cable entry access holes for work tops
- Standard black fabric screen

SHUSH30 SCREEN HUNG WORKSTATIONS



SIDE TO SIDE



BACK TO BACK



The SHUSH30 screen range features a 30mm slimline screen with a square profile, powder coat frame and a full fabric pinnable surface with adjustable levelling feet.

The two heights allow for either full communication or some privacy between users.

Comes in 2 standard colour options or can be upholstered in our House Fabrics range.

*Lead times and additional charges apply

The SHUSH30 is a screen system that can create endless configurations. Create runs of any length. Use the 2 different screen heights to create privacy or encourage teamwork. Use completely screen hung tops with no legs or use with Profile, Loop, Eternity, Span or DC-60 legs. (See next page)

Top Finishes :

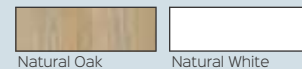

Screen Finishes :



House Fabrics

See page 72

Certifications :



The SHUSH30 is a screen system that can create endless configurations, using the below components. Create runs of back to back pods, mix and match heights and colours.

Components :

Top Options	Natural Oak or Natural White with scalloped edge DST1275 - 1200mm W x 750mm D DST1575 - 1500mm W x 750mm D DST1875 - 1800mm W x 750mm D
Screen Options	Black frame with Grey Fabric or White frame with Grey fabric IS712 - 750mm W x 1200mm H x 30mm T IS1212 - 1200mm W x 1200mm H x 30mm T IS1512 - 1500mm W x 1200mm H x 30mm T IS1812 - 1800mm W x 1200mm H x 30mm T IS715 - 750mm W x 1500mm H x 30mm T IS1215 - 1200mm W x 1500mm H x 30mm T IS1515 - 1500mm W x 1500mm H x 30mm T IS1815 - 1800mm W x 1500mm H x 30mm T
Joining Pole	White or Black ISJP1200 - Joining Pole for 1200mm Height ISJP1500 - Joining Pole for 1500mm Height

SHUSH30 CUBICLE



Create freestanding cubicles without constructing permanent walls.

Use taller screens to create private personal pods without the construction of walls.

Join pods to create as many cubicles as you require for your office set up.

SHUSH30 CORNER 1-2 person



Corner desks for more work space per user. Create a free standing self contained temporary cubicle that can be deconstructed and moved.

Components :

Corner	Natural Oak or Natural White with cable entry hole
Top	T1515-75 - 1500mm x 1500mm, 750mm Top Depth
Size	T1812-75 - 1800mm x 1200mm, 750mm Top Depth
Options	T1815-75 - 1800mm x 1500mm, 750mm Top Depth T1818-75 - 1800mm x 1800mm, 750mm Top Depth

SHUSH30 CORNER 4+



Create large team pods.

Use completely screen hung tops with no legs or use with Profile, Loop, Eternity, Span or DC-60 end legs.

Use ceiling to workstation power poles and umbilicals to take power to the workstations neatly and safely.

LEG OPTIONS

Mix and Match with Profile, Loop, Eternity, Span or DC-60 end legs with middle dividing screens.

Leg Options	Profile Leg - in Black or White Loop Leg - in Black or White Eternity Leg - in Black or White DC60 - Round leg in Chrome, Black or White SPLEG - Span leg in Silver, Black or White
-------------	---



*Pictured with Black Eternity end legs



*Pictured with White DC-60 end legs

RAPID SCREEN



RAPID SCREEN STRAIGHT PODS



RAPID SCREEN CORNER PODS

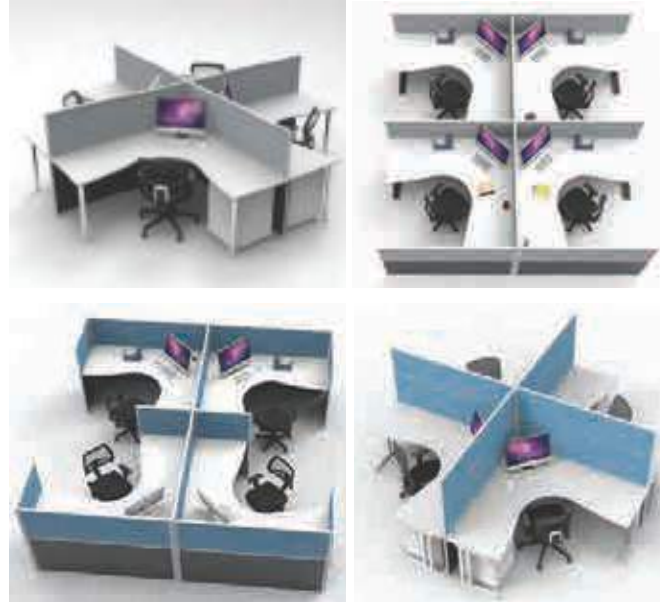

RAPID SCREEN 120° DEGREE PODS



Create a layout to suit your space with a huge selection of tops, legs, and colours to choose from.

Components :

Top Options	Beech or Natural White with cable entry holes T127 - 1200mm W x 700mm D T157 - 1500mm W x 700mm D T187 - 1800mm W x 700mm D
Screen Options	Blue or Grey fabric with ironstone bottom SC712 - 750mm W x 1250mm H x 30mm T SC1212 - 1200mm W x 1250mm H x 30mm T SC1512 - 1500mm W x 1250mm H x 30mm T SC1812 - 1800mm W x 1250mm H x 30mm T SC716 - 750mm W x 1650mm H x 30mm T SC1216 - 1200mm W x 1650mm H x 30mm T SC1516 - 1500mm W x 1650mm H x 30mm T SC1816 - 1800mm W x 1650mm H x 30mm T
Leg Options	DC60 - Round leg in Chrome, Black or White SPLEG - Span leg in Silver, Black or White C LEG - C Leg in Silver only
Joining Pole	Precious Silver SC12/90 - 90° Degree Pole for 1200mm Height SC16/90 - 90° Degree Pole for 1600mm Height

Encourage teamwork while providing privacy.

Components :

Top Options	Beech or Natural White with cable entry hole T1515 - 1500mm x 1500mm, 700mm Top Depth T1812 - 1800mm x 1200mm, 700mm Top Depth T1815 - 1800mm x 1500mm, 700mm Top Depth T1818 - 1800mm x 1800mm, 700mm Top Depth
Screen Options	Blue or Grey fabric with ironstone bottom SC712 - 750mm W x 1250mm H x 30mm T SC1212 - 1200mm W x 1250mm H x 30mm T SC1512 - 1500mm W x 1250mm H x 30mm T SC1812 - 1800mm W x 1250mm H x 30mm T SC716 - 750mm W x 1650mm H x 30mm T SC1216 - 1200mm W x 1650mm H x 30mm T SC1516 - 1500mm W x 1650mm H x 30mm T SC1816 - 1800mm W x 1650mm H x 30mm T
Leg Options	DC60 - Round leg in Chrome, Black or White SPLEG - Span leg in Silver, Black or White C LEG - C Leg in Silver only
Joining Pole	Precious Silver SC12/90 - 90° Degree Pole for 1200mm Height SC16/90 - 90° Degree Pole for 1600mm Height

Spacious workstations per user while still providing sufficient privacy.

Components :

Top Options	Beech or Natural White with cable entry hole T1212-12-7 - 120° Degree Top 1200mm W x 1200mm W x 700mm D
Screen Options	Blue or Grey fabric with ironstone bottom SC712 - 750mm W x 1250mm H x 30mm T SC1212 - 1200mm W x 1250mm H x 30mm T SC716 - 750mm W x 1650mm H x 30mm T SC1216 - 1200mm W x 1650mm H x 30mm T
Leg Options	DC60 - Round leg in Chrome, Black or White SPLEG - Span leg in Silver, Black or White C LEG - C Leg in Silver only
Joining Pole	Precious Silver SC12/120 - 120° Degree Pole for 1200mm Height SC16/120 - 120° Degree Pole for 1600mm Height

Certifications :



RAPID SCREEN COMPONENTS

CHOOSE YOUR TABLE TOP

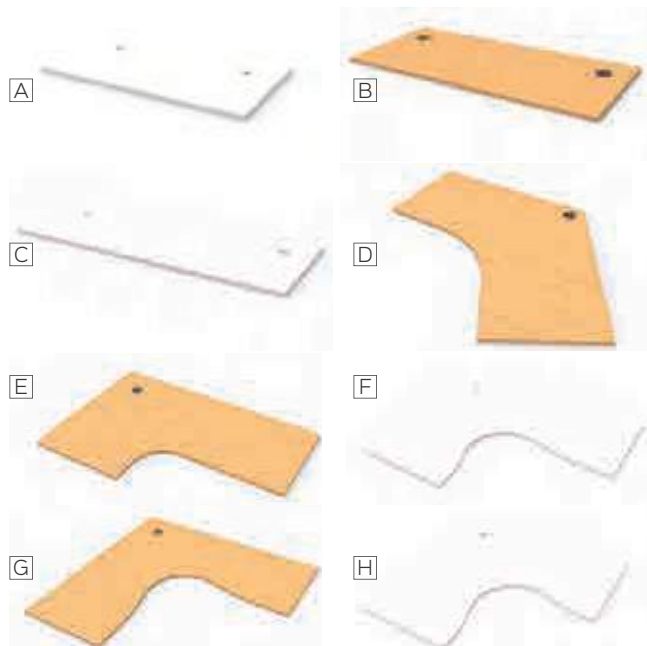

Specifications :

Key	Code	Width	Depth	Thickness
A	T127	1200mm	700mm	25mm
B	T157	1500mm	700mm	25mm
C	T187	1800mm	700mm	25mm
D	T1212-12	1200 x 1200mm	700mm	25mm
E	T1812	1800 x 1200mm	700mm	25mm
F	T1815	1800 x 1500mm	700mm	25mm
G	T1818	1800 x 1800mm	700mm	25mm
H	T1515	1500 x 1500 mm	700mm	25mm

Finish Options :



Certifications :



The Rapid Screen system allows ultimate flexibility to suit your space. Different top shapes and sizes, screen heights, leg options and storage choices allow for personalised workstation design.

CHOOSE YOUR LEG STYLE



Specifications :

Key	Code	Description	Dimensions	Qty
I	SPLEG	Span Leg	560W x 705H	2
J	DC60	Round Leg	60 Dia. x 705H	4
K	CLEG	C Leg	550W x 705H	2

Finish Options :



Certifications :



JOINING POLES



Specifications :

Key	Code	Description	Dimensions
L	SC12/90	Join screens at 90°	30 Dia. x 1250 H
L	SC12/120	Join screens at 120°	30 Dia. x 1250 H
M	SC16/90	Join screens at 90°	30 Dia. x 1650 H
M	SC16/120	Join screens at 120°	30 Dia. x 1650 H

Finish :

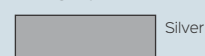

Certifications :



CHOOSE YOUR SCREEN

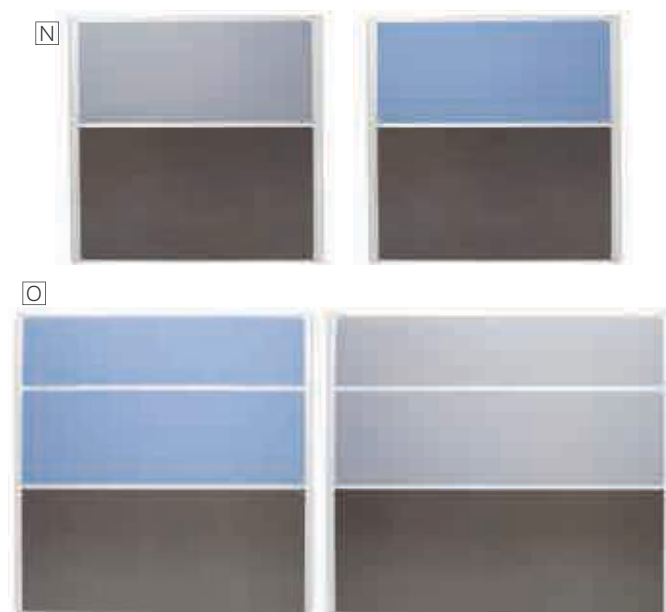

Specifications :

Key	Code	Width	Depth	Height
N	SC1212	1200mm	30mm	1250mm
-	SC1512	1500mm	30mm	1250mm
-	SC1812	1800mm	30mm	1250mm
-	SC712	750mm	30mm	1250mm
-	SC1216	1200mm	30mm	1650mm
O	SC1516	1500mm	30mm	1650mm
-	SC1816	1800mm	30mm	1650mm
-	SC716	750mm	30mm	1650mm

Finish Options :



Certifications :



Features :

Fabric top half can be upholstered in a range of house fabrics with a lead time

CHOOSE YOUR SCREEN ACCESSORIES

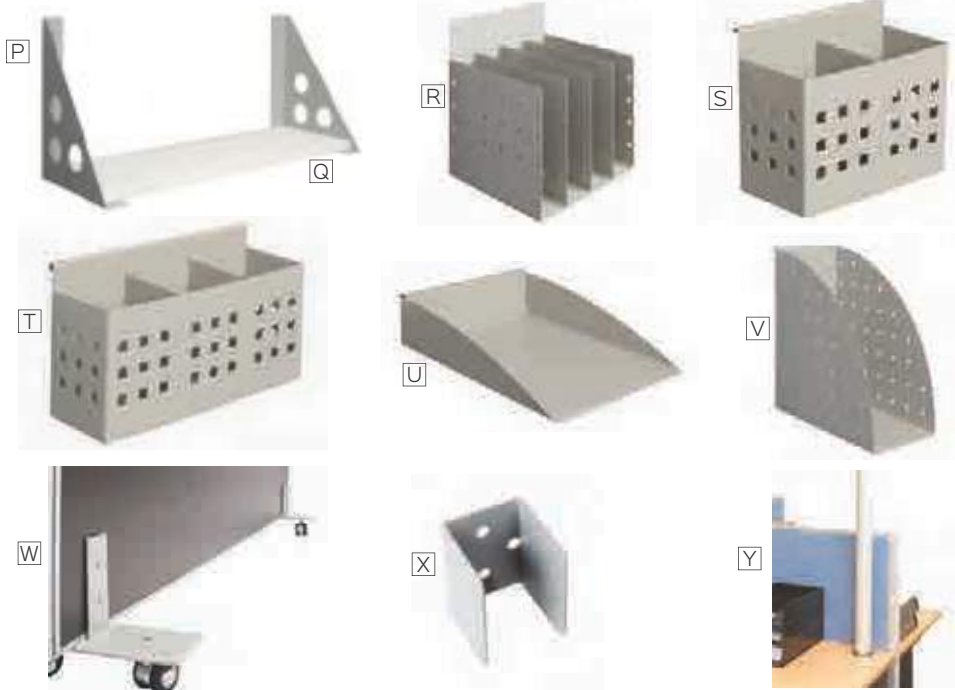

Specifications :

Key	Code	Description	Colour
P	SCSHELF BRACKET	Shelf Brackets	Silver
Q	SCSHELF	900mm W Shelf	Beech or Natural White
R	SCDOC DIVIDE	4 Space Document Divider	Silver
S	SCPENHOLDER 2	Double Pen Holder	Silver
T	SCPENHOLDER 3	Triple Pen Holder	Silver
U	SCDOCTRAY	A4 Document Tray	Silver
V	SCFILE HOLDER	File Holder	Silver
W	SCFREE STANDING FEET	Free Standing Detachable Castor Feet	Silver
X	SCWALLBRACKET	Wall to Screen Starter Bracket	Silver
Y	SW2.1 POWER POLE or SW2.8 POWER POLE	Power Pole Available in 2100mm or 2800mm Height	Silver

Finish :

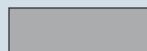

Silver

Shelf Finish Options :

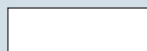

Natural White

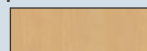

Beech

Certifications :



DELUXE RAPID SPAN

STRAIGHT DESKS



RSD1275M WNO
White Frame
Natural Oak Top with Scalloped Edge



RSD1575M SNO
Silver Frame
Natural Oak Top with Scalloped Edge



RSD1875M BNO
Black Frame
Natural Oak Top with Scalloped Edge

CORNER WORKSTATIONS



RSCWS181275M WNO
1800 x 1200mm Corner Top | White Frame
Natural Oak Top with Single Cable Entry Hole



RSCWS181575M SNO
1800 x 1500mm Corner Top | Silver Frame
Natural Oak Top with Single Cable Entry Hole



RSCWS181875M BNO
1800 x 1800mm Corner Top | Black Frame
Natural Oak Top with Single Cable Entry Hole

Deluxe Rapid Span - 750mm Deep desk top in Natural Oak or Natural White finish. Top matches Deluxe Infinity Storage.

The Span range of desking can be configured in back to back desk layouts and pods of workstations as well as stand alone desks. Contact us today for more information.

Desk Size Options :

Product Code	Width	Top Depth	Height
RSD1275M	1200mm	750mm	730mm
RSD1575M	1500mm	750mm	730mm
RSD1875M	1800mm	750mm	730mm

Corner Workstaion Size Options :

Product Code	Width	Top Depth	Height
RSCWS181275M	1800 x 1200mm	750mm	730mm
RSCWS151575M	1500 x 1500mm	750mm	730mm
RSCWS181575M	1800 x 1500mm	750mm	730mm
RSCWS181875M	1800 x 1800mm	750mm	730mm

Top Finish :

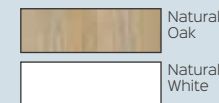

Certifications :



Frame Finishes :

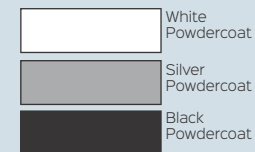

Features :

- Sturdy powdercoated frame and legs
- Comes with metal perforated modesty panel
- Range of sizes to choose from to suit your space
- E0 Melamine top
- Pre cut cable entry hole or scalloped edge
- 750mm Deep top for more workspace
- Hidden cable tidy in legs
- Adjustable feet
- Use with Deluxe Infinity storage. (See page 17)

STRAIGHT DESKS



RSD187M WNW
White Frame
Natural White Top with Cable Entry Holes



RSD187M SB
Silver Frame
Beech Top with Cable Entry Holes



RSD187M BNW
Black Frame
Natural White Top with Cable Entry Holes

CORNER WORKSTATIONS



RSCWS1818M BB
Corner Workstation | Black Frame
Beech Top with Single Cable Entry Hole



RSCWS1818M SNW
Corner Workstation | Silver Frame
Natural White Top with Single Cable Entry Hole



RSDR1818M WB
Desk and Return | White Frame
Beech Top with Cable Entry Holes

Rapid Span Desks - Mix and match colours and sizes.

The Rapid Span range of desking can be configured in back to back desk layouts and pods of workstations as well as stand alone desks. All desks and corner workstations are 700mm deep.

Contact us today for more information.

Desk Size Options :

Product Code	Width	Depth	Height
RSD127	1200mm	700mm	730mm
RSD157	1500mm	700mm	730mm
RSD187	1800mm	700mm	730mm

Corner Workstation Size Options :

Product Code	Width	Depth	Height
RSCWS1812	1800 x 1200mm	700mm	730mm
RSCWS1515	1500 x 1500mm	700mm	730mm
RSCWS1815	1800 x 1500mm	700mm	730mm
RSCWS1818	1800 x 1800mm	700mm	730mm

Desk with Return Size :

Product Code	Width	Depth	Height
RSDR1818	1800mm x 1800mm (1100 x 600mm D Return)	700mm	730mm

Top Finishes :

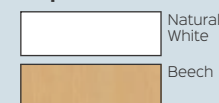

Frame Finishes :

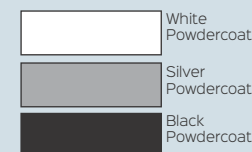

Certifications :



Features :

- Mix and match choice of 2 top colours and 3 frame colours
- E0 Melamine top with pre cut cable entry hole
- Sturdy powdercoated frame and legs
- Comes with metal perforated modesty panel
- Range of sizes to choose from to suit your space
- Pre cut cable entry holes
- 700mm Deep top to suit smaller spaces (600mm D return in RSD1818)
- Hidden cable tidy in legs
- Adjustable feet

RAPID SPAN STORAGE

RAPID SPAN CUPBOARD - SP2FD18

Specifications :

Width	900mm
Depth	450mm
Height	1800mm

Features :

- Includes 1 x fixed mid shelf
- 3 x adjustable shelves
- Soft close hinges
- Fully lockable with 2 keys included
- E0 Melamine board

Finish Options :

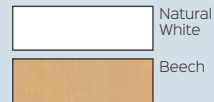

Certifications :



RAPID SPAN BOOKCASE

Specifications :

Width	900mm
Depth	315mm
Height	• SPBC12 - 1200mm
Options	• SPBC18 - 1800mm

Features :

- E0 Melamine board
- 1200mm H comes with 3 x adjustable shelves, 1800mm H comes with 4 x adjustable shelves.

Finish Options :

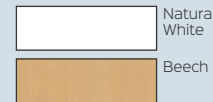

Certifications :



RAPID SPAN CREDENZA

Specifications :

Width	• SPC12 - 1200mm
Options	• SPC18 - 1800mm
Depth	450mm
Height	730mm

Features :

- Sliding door credenza
- Includes 2 x adjustable shelves
- Fully lockable with 2 keys included
- E0 Melamine board

Finish Options :

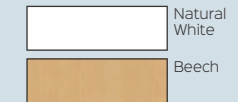

Certifications :



UNDER DESK STORAGE - SPMP3

Specifications :

Width	447mm
Depth	465mm
Height	690mm
Weight Rating	30kg per Drawer

Features :

- Melamine mobile pedestal on castors
- 2 x personal drawers and 1 x file drawer
- Lockable with key, 2 keys supplied
- E0 Melamine board

Top Finishes :

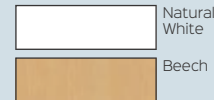

Certifications :



RAPID SPAN HUTCH

Specifications :

Width	• SPH12 - 1200W - 2 Vertical sections
Options	• SPH18 - 1800W - 3 vertical sections
Depth	315mm
Height	1070mm

Features :

- Includes adjustable shelves
- Sits on top of credenza
- Provides extra storage space
- E0 Melamine board

Finish Options :

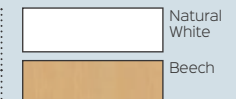

Certifications :



STRAIGHT DESK · ELECTRIC HEIGHT ADJUSTABLE



SE-157 SNW
Silver Frame | 1500mm Top
Natural White Top with Cable Entry Holes

CORNER WORKSTATION · ELECTRIC HEIGHT ADJUSTABLE



SE15157 BNW
Black Frame | 1500mm x 1500mm
Natural White Top with Cable Entry Hole



SE-187 BB
Black Frame | 1800mm Top
Beech Top with Cable Entry Holes



SE18187 WB
White Frame | 1800mm x 1800mm
Beech Top with Cable Entry Hole



SE-187 WNW
White Frame | 1800mm
Natural White Top with Cable Entry Holes



SE-18187 SB
Silver Frame | 1800mm x 1800mm
Beech Top with Cable Entry Holes

RAPID SPAN ELECTRIC HEIGHT ADJUSTABLE WORKSTATION

The Rapid Span range of desks can be configured in back to back desk layouts and pods of workstations as well as stand alone desks, in fixed or electric height adjustable.

Contact us today for more information.

Size Options :

Product Code	Width	Depth	Height Range
SE-127	1200mm	700mm	685 - 1205mm
SE-157	1500mm	700mm	685 - 1205mm
SE-187	1800mm	700mm	685 - 1205mm
SE-18127	1800 x 1200mm	700mm	685 - 1205mm
SE-15157	1500 x 1500mm	700mm	685 - 1205mm
SE-18157	1800 x 1500mm	700mm	685 - 1205mm
SE-18187	1800 x 1800mm	700mm	685 - 1205mm

Top Finishes :

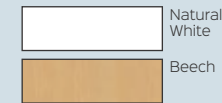

Frame Finishes :

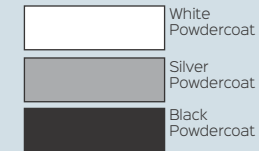

Certifications :



Features :

- Mix and match choice of 2 top colours and 3 frame colours
- Range of sizes and shapes to choose from
- E0 Melamine top with pre cut cable entry hole
- Height adjustment between 685mm to 1205mm
- Stiffening rail for 1500mm W and 1800mm W tops
- 31mm per second electric height adjustment speed
- 100kg maximum top load rating

OPTIONAL PRE SET CONTROLLER



Features :

- Offers the ability to program 3 different height settings for up to 3 individual users each
- Or use the up and down buttons for quick adjustment to desk height without affecting the programmed heights
- Programmable handset can be added to electric height adjustable desk at anytime

- Available for Extra
- Product Code: SS-PSC

RAPID BOOST HEIGHT ADJUSTABLE



RAPID BOOST

Specifications :

Top Width Options	<ul style="list-style-type: none"> • 1200mm • 1500mm • 1800mm
Top Depth Options	<ul style="list-style-type: none"> • 700mm with Cable Entry Holes Only • 750mm with Scalloped Edge Only
Height Range	620mm - 1250mm
Weight Capacity	125kg

Features :

- Easy height adjustment with up and down buttons for control
- Memory controller included as standard, saves 3 heights
- Controller displays height in MM
- Max speed 38mm per second
- 3 Stage Legs with Dual Motors
- Built In Anti-Collision Mechanism
- Weight capacity 125kg
- Suitable for custom tops from 1200mm - 2000mm wide
- Suitable for custom tops from 600mm - 800mm depth
- E0 Melamine board top

Top Options :

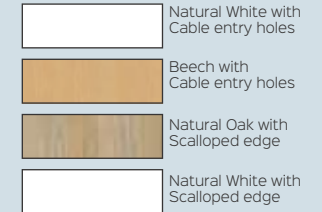

Frame Finishes :

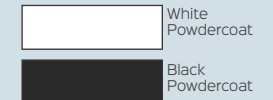

Certifications :



SINGLE SIDED · WITH OR WITHOUT SCREEN



NPM1P1575 NOWS
White Frame
Scalloped Edge
1500mm, Natural Oak Top

DOUBLE SIDED · WITH OR WITHOUT SCREEN



NPM2P1575 NO/BL
Black Frame
Scalloped Edge
1500mm, Natural Oak Tops



NPM1PWS1875 NW/BL
Black Frame
Scalloped Edge
1800mm, Natural White Top



NPM2PWS1875 NW/WS
White Frame
Scalloped Edge
1800mm, Natural White Tops

CLAMP ON SHELF



CMSHELF600
Black with Natural Oak or
White with Natural White

OPTIONAL PRE-SET CONTROLLER



NPM2PWS1875 NW/WS
White Frame, Scalloped Edge
1800mm, Natural Oak Tops
*With Pre-set controller installed

PARAMOUNT HEIGHT ADJUSTABLE WORKSTATION

Single Sided Options :

Product Code	Users	Screen	Width	Depth	Height Range
NPM1P1575	1	None	1500mm	750mm	655 - 1259mm
NPM1P1875	1	None	1800mm	750mm	655 - 1259mm
NPM1PWS1575	1	Yes	1500mm	780mm	655 - 1259mm
NPM1PWS1875	1	Yes	1800mm	780mm	655 - 1259mm

Double Sided Options :

Product Code	Users	Screen	Width	Depth	Height Range
NPM2P1575	2	None	1500mm	1530mm	655 - 1259mm
NPM2P1875	2	None	1800mm	1530mm	655 - 1259mm
NPM2PWS1575	2	Yes	1500mm	1530mm	655 - 1259mm
NPM2PWS1875	2	Yes	1800mm	1530mm	655 - 1259mm

Features :

- 25mm Thick E0 melamine board table top with 50mm D scalloped edge for cable access
- New Cable Tray Design With Provisions To Hold Up To 12 GPO Or Data Points Per User
- Modular Wiring Components Not Included – See Softwiring Range
- Powder Coated 3 Stage Frame with a Single Heavy Duty Motor
- 100kg Lifting Capacity
- Optional 30mm Thick screen with pinnable fabric
- New Desk Mounted & Clamp On Shelf Options
- Optional Pre-set Controller compatible

Top Options :

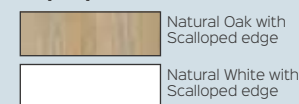

Frame Finishes :

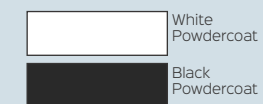

Screen Finishes :



Certifications :



Optional Clamp on shelf :

- Available in White with White or Black with Natural Oak
- Clamps onto desk top
- 25mm Thick E0 Rated Enviroboard Shelf
- Drilled Provisions For Wire Dividers
- 4 x Wire Dividers Included

Optional Pre-set controller :

- Offers the ability to program 3 different height settings for up to 3 individual users each
- Or use the up and down buttons for quick adjustment to desk height without affecting the programmed heights
- Programmable handset can be added to electric height adjustable desk at anytime
- Available for Extra
- Product Code: SS-PSC



HEIGHT ADJUSTABLE SOLUTIONS

RAPID FLUX

Specifications :

Top Width	• RF1 - 880mm • RF2 - 950mm
Depth	Overall - 590mm, Top - 415mm
Height	120mm - 500mm
Weight Capacity	25kg on Top

Finish Options :



Features :

- Electric height adjustable solution for fixed desk
- 22mm per second speed
- Hidden motor makes for a compact design
- Grommet Hole in Worktop for Use with Monitor Arms

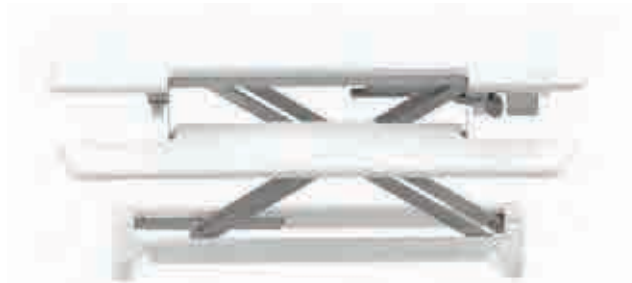

RAPID RISER

Specifications :

Top Width	• RR1 - 680mm • RR2 - 890mm
Top Depth	590mm
Height	150mm - 500mm
Weight Capacity	15kg Weight Capacity on RR1 18kg Weight Capacity on RR2

Finish Options :

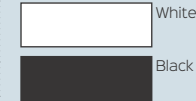

Features :

- Manual height adjustable solution for fixed desk
- 15 Different height level settings
- Comes with hole for monitor arm installation



TRIUMPH MANUAL HEIGHT ADJUSTABLE

Specifications :

Top Width	• TMA127 - 1200mm • TMA157 - 1500mm • TMA187 - 1800mm
Top Depth	700mm
Height	715-1015mm
Weight Capacity	100kg on Top

Top Finishes :



Frame :



Features :

- Manual height adjustable desk
- Universal left or right hand side crank handle
- Intergrated cable dump tray



RAPID REFRESH MAT - RRM BL

Specifications :

Width	900mm
Depth	600mm
Thickness	19mm
Weight	2.4kg

Features :

- Anti-fatigue mat
- 100% PU material
- Use with any height adjustable solution
- Updated Design

Top Finishes :

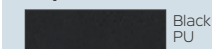

EXECUTIVE SINGLE MONITOR ARM - ESMARM

Specifications :

Tilt Range	-85° to 15°
Screen Size	17" to 27"
Vesa Size	75 x 75mm or 100 x 100mm
Weight Limit	Min. 2kg - Max 9kg
Fixing	Clamp and Grommet Fix Kit

Finish Options :



Features :

- Gas spring single monitor arm with effortless rotating, pivoting and extendable adjustments.



REVOLVE SINGLE MONITOR ARM - RMA1 BL

Specifications :

Arm Reach	435mm
Pole Height	392mm
Height	200-340mm
Weight Limit	10kg
Movement Range	-85° to 15°

Finish Options :



Features :

- Pole mounted single monitor arm with 200-360mm height range and cable management within.



ELEVATE SINGLE MONITOR ARM - ELEVATE

Specifications :

Forward Range	500mm
Vertical Range	180-480mm
Size Limit	Up to 24 Inch Monitor
Weight Limit	Min. 2kg - Max 8kg
Movement Range	180°

Finish Options :



Features :

- Single swivel monitor arm with 160-480mm height range, 180° degree adjustment and clamp fix kit.



EXECUTIVE DUAL MONITOR ARM - EDMARM

Specifications :

Tilt Range	-85° to 15°
Screen Size	17" to 27"
Vesa Size	75 x 75mm or 100 x 100mm
Weight Limit	Min. 2kg - Max 9kg per Arm
Fixing	Clamp and Grommet Fix Kit

Finish Options :



Features :

- Gas spring dual monitor arms with effortless rotating, pivoting and extendable adjustments.



REVOLVE DUAL MONITOR ARM - RMA2 BL

Specifications :

Arm Reach	360mm per Arm
Pole Height	450mm
Height	260-360mm
Weight Limit	10kg per Arm
Movement Range	-85° to 15°

Finish Options :



Features :

- Pole mounted dual monitor arm with 200-400mm height range and cable management within, in black finish.



REVOLVE QUAD MONITOR ARM - RMA4 BL

Specifications :

Arm Reach	360mm per Arm
Pole Height	708mm
Height	200-660mm
Weight Limit	10kg per Arm
Movement Range	-85° to 15°

Finish Options :



Features :

- Pole mounted quad monitor arm with 200-660mm height range and cable management within, in black finish.

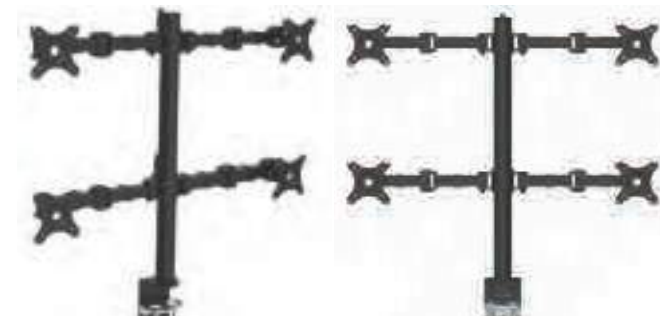

CABLE MANAGEMENT SOLUTIONS

ECHO WIRELESS CHARGER

Specifications :

Width	60mm Diameter
Power	15W
Includes	500mm TAG lead with L3F splitter or 1500mm lead with 3-pin plug

Finish Options :



Certifications :



Features :

- Wireless fast charging module that can fit into desk top. *Check compatibility with phone brands.



ODYSSEY POWER DOCK

Specifications :

Includes	4 x GPO + 2 x Type C/A USB Fast Charge + 1500mm lead with 10A 3-pin plug *Other Configurations Available. Please enquire
----------	---

Finish Options :

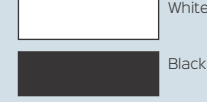

Certifications :



Features :

- The complete power solution for where shared power is needed. Use in boardrooms, conference areas, hot desking or meetings.



ATOM USB CHARGING MODULE

Specifications :

Includes	2 x USB *Under-desk mounting bracket sold seperately*
----------	--

Finish Options :



Certifications :



Features :

- USB charging module
- Can be integrated into desk top or fixed underneath desk top, or mounted to lounges with a mounting bracket.



BLINKY POWER POD

Specifications :

Size	Fits in 135mm Diameter cutout
Available Options	• 3 x GPO + 500mm TAG lead • 3 x GPO + 1500mm lead with 10A 3-pin plug • 3 x GPO + 3 x Type C/A Fast Charge + 500mm TAG lead • 3 x GPO + 3 x Type C/A Fast Charge + 1500mm lead with 10A 3-pin plug

Features :

- Multi-power pod with different power configurations available
- Sits on desk top

Finish Options :



Certifications :



POWER POLE AND UMBILICAL

Specifications :

Desk to Ceiling Kit Includes	2.1m power pole or umbilical kit for desk to ceiling power with ceiling kit, under desk mounting bracket, desk grommet and cover
Floor to Ceiling Kit Includes	2.8m power pole or umbilical kit for floor to ceiling power with ceiling kit, floor bracket and cover

Features :

- Carries cables and wiring to your desk from the ceiling
- Perfect for open plan offices for desks in the centre of the room

Finish Options :

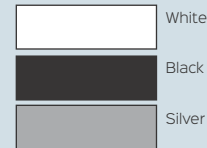

Certifications :



TRAX

Specifications :

Length	1200mm
Available Options	Single Compartment for power or Dual Compartment for power and data

Finish Options :



Certifications :



Features :

- Solution for height adjustable desks
- Cable tray to workstation umbilical
- Includes tray base fixing, and under desk bracket



SINGLE TIER CABLE BASKET KIT

Specifications :

Available Widths	<ul style="list-style-type: none"> • 650mm for 900mm Desks • 950mm for 1200mm Desks • 1250mm for 1500mm Desks • 1550mm for 1800mm Desks
Available Options	<ul style="list-style-type: none"> • 2 x GPO • 4 x GPO

Finish Options :

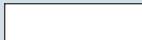
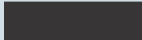
	White
	Black

Features :

- Under desk cable basket kit to organise cables, for power only. Includes basket, power module, gpo clip and interconnecting lead.



DUAL TIER CABLE BASKET KIT

Specifications :

Available Widths	<ul style="list-style-type: none"> • 650mm for 900mm Desks • 950mm for 1200mm Desks • 1250mm for 1500mm Desks • 1550mm for 1800mm Desks
Available Options	<ul style="list-style-type: none"> • 2 x GPO with 2 Data tiles • 4 x GPO with 2, 3 or 4 Data

Finish Options :

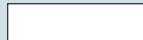
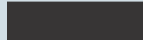
	White
	Black

Features :

- Under desk cable basket kit to organise cables. Includes basket, power module, gpo clip, interconnecting lead and data tile.





ATHENA POWER RAIL KIT

Specifications :

Available Options	<ul style="list-style-type: none"> • 2 x Rotated GPO • 2 x GPO + 2 x USB • 2 x GPO + 2 Data Provision • 4 x GPO + 3 x Data Provision
-------------------	--

Finish Options :

	White
	Black

Features :

- Includes 500mm Tag Lead D & Splitter
- Clamps onto desk top
- Comes with desk clamps
- Range of configurations to choose from

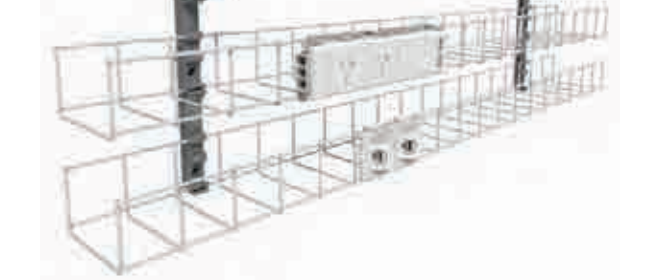



BOARDROOM TABLE BOX

Specifications :

Available Options	<ul style="list-style-type: none"> • 2 x GPO + 3 Data Provision • 4 x GPO + 5 x Data Provision
-------------------	--

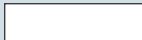
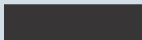
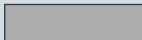
Finish Options :

	White
	Black
	Silver

Features :

- Sits in desk or table top
- Lid closes to hide points when not in use
- Leads not included



POP UP POWER

Specifications :

Available Options	<ul style="list-style-type: none"> • 2 x GPO • 1 x GPO + 2 x USB
-------------------	--

Finish Options :

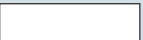
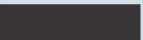
	White
	Black

Features :

- Pop up power module
- Offers above desk power, data and USB
- Can be concealed when not in use
- Leads not included





IN DESK MODULE

Specifications :

Available Options	<ul style="list-style-type: none"> • 1 x GPO • 1 x GPO, 2 x USB + 1 x Keystone Jack
-------------------	---

Finish Options :

	White
	Black

Features :

- In desk module
- Offers above desk power, data and USB
- Fits into 80mm cable entry holes
- Leads not included



RECTANGULAR TABLES

TYPHOON FLIP TOP TABLE

Specifications :

Top Width Options	• TFT1575 - 1500mm • TFT1875 - 1800mm
Top Depth	750mm
Table Height	750mm

Features :

- Premium flip top table
- Locking castors
- Easy storage when not in use
- Table links available for extra
- Matching Boardroom and Round tables
- E0 Melamine board table top

Top Options :



Base :



FOLDING TABLE

Specifications :

Top Size Options	• FFT1575 - 1500W x 750D • FFT1875 - 1800W x 750D • FFT189 - 1800W x 900D
Table Height	730mm

Features :

- Steel folding frame
- Adjustable levelling feet
- Suitable for heavy duty use
- Easy storage when not in use
- Easy to use folding mechanism
- E0 Melamine board table top

Top Options :

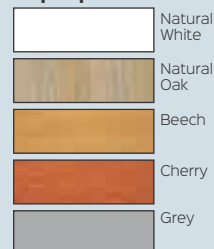

Base :

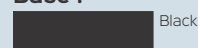

BUDGET FLIP TOP TABLE

Specifications :

Top Width Options	• FTT1575 - 1500mm • FTT1875 - 1800mm
Top Depth	750mm
Table Height	730mm

Features :

- Flip top table
- Powdercoated frame
- Padded pull handle
- Locking castors
- Table links available for extra
- E0 Melamine board table top

Top Options :

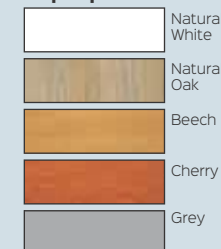

Base :

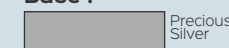

RAPID EDGE FOLDING TABLE - FBT2410

Specifications :

Top Width	2400mm
Top Depth	1000mm
Table Height	743mm

Features :

- Folding table, top folds in half
- Black rubber strip edging
- Quick release mechanism
- Includes 2 x table links

Top Options :

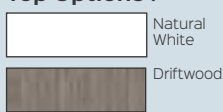

Base :



STEEL FRAME TABLE

Specifications :

Top Size Options	• SFT126 - 1200W x 600D • SFT1575 - 1500W x 750D • SFT1875 - 1800W x 750D • SFT189 - 1800W x 900D
Table Height	730mm

Features :

- Black steel frame
- Adjustable levelling feet
- E0 Melamine board table top

Top Options :



Base :

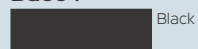

SILVER FRAME TABLE

Specifications :

Top Size Options	• RST1875 - 1800W x 750D • RST189 - 1800W x 900D
Table Height	730mm

Features :

- Stylish angled frame
- Adjustable feet
- E0 Melamine board table top

Top Options :



Base :

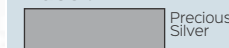





ETERNITY ROUND TABLE

Specifications :

Top Diameter Options	• D-ERT9 - 900mm • D-ERT12 - 1200mm
Overall Height	730mm

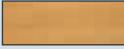

Top Options :

-  Natural White
-  Natural Oak
-  Beech
-  Cherry

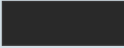
Base Options :

-  White
-  Black

Certifications :

Features :

- Powdercoated base
- Adjustable feet
- 45 degree profile to leg
- Matches Eternity range
- E0 Melamine board table top







RAPID AIR ROUND TABLE

Specifications :

Top Diameter Options	• RAR9 - 900mm • RAR12 - 1200mm
Overall Height	750mm

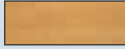

Top Options :

-  Natural White
-  Natural Oak
-  Beech
-  Cherry

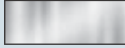
Base :

-  Polished Aluminium

Certifications :

Features :

- Round meeting table
- Modern tripod polished aluminium base
- Matches Rapid Air boardroom range
- E0 Melamine board table top







TYPHOON ROUND TABLE

Specifications :

Top Diameter Options	• TTR9 - 900mm • TTR12 - 1200mm
Table Height	730mm

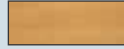

Top Options :

-  Natural White
-  Natural Oak
-  Beech
-  Cherry

Base :

-  Polished Aluminium

Certifications :

Features :

- Round meeting table
- 4 star black and polished aluminium base
- Adjustable feet
- Matches Typhoon range
- E0 Melamine board table top







DISC BASE TABLE

Specifications :

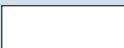
Top Diameter Options	• CBT9 - 900mm • CBT12 - 1200mm
Table Height	755mm

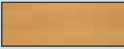

Top Options :

-  Natural White
-  Natural Oak
-  Beech
-  Cherry

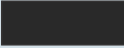
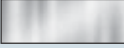
Base Options :

-  White
-  Black
-  Stainless Steel

Certifications :

Features :

- Round meeting table
- 2 different top sizes
- Flush flat disc base
- E0 Melamine board table top





FOUR STAR BASE ROUND TABLE

Specifications :

Top Diameter Options	• 900mm • 1200mm
Table Height	730mm

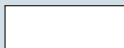

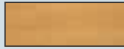
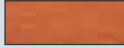
Top Options :

-  Natural White
-  Natural Oak
-  Beech
-  Cherry

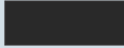
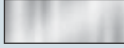
Base Options :

-  White
-  Black
-  Stainless Steel

Certifications :

Features :

- Round meeting table
- 4 star base
- 2 different sizes
- E0 Melamine board table top





IRONSTONE BASE ROUND TABLE

Specifications :

Top Diameter Options	• CRM9 - 900mm • CRM12 - 1200mm
Table Height	730mm



Top Options :

-  Beech
-  Cherry

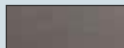
Base :

-  Ironstone

Certifications :

Features :

- Full E0 Melamine board Top and Base
- Solid melamine ironstone base
- Available in 2 sizes and 2 top finishes
- Matches with Rapid Worker range



BOARDROOM TABLES

RAPID AIR BOARDROOM TABLE

Specifications :

Size	• RAB2412 - 2400W x 1200D
Options	• RAB3212 - 3200W x 1200D
Height	750mm

Features :

- Suspended floating top
- Available with single or dual stage frame
- 1-Piece Top for 2400mm size
- 2-Piece Top for 3200mm size
- E0 Melamine board table top

Certifications :



Top Options :

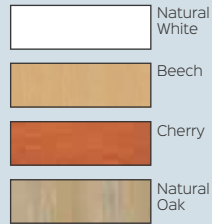

Base :

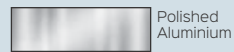

TYPHOON BOARDROOM TABLE

Specifications :

Size	• TTR189 - 1800W x 900D
Options	• TTR2412 - 2400W x 1200D
	• TTR3212 - 3200W x 1200D
Height	750mm

Features :

- Available in 3 sizes
- Single or dual stage frame
- E0 Melamine board table top

Certifications :



Top Options :



Base :



IRONSTONE BASE BOARDROOM TABLE

Specifications :

Size	• CBT2412 - 2400W x 1200D
Options	• CBT3212 - 3200W x 1200D
Height	730mm

Features :

- Made entirely of E0 Melamine board
- Sturdy H shape base
- 1-Piece Top for 2400mm size
- 2-Piece Top for 3200mm size

Certifications :



Top Options :



Base :



Rapid Air Boardroom
Cherry Top
2400mm x 1200mm



Typhoon Boardroom
Beech Top
2400mm x 1200mm



Ironstone Base Boardroom
Natural Oak Top
2400mm x 1200mm



Rapid Air Boardroom
Natural White Top
3200mm x 1200mm



Typhoon Boardroom
Natural White Top
3200mm x 1200mm



Ironstone Base Boardroom
Natural White Top
3200mm x 1200mm

DRY BAR TABLE - CDBT6

Specifications :

Top Size	600mm Diameter
Table Height	1050mm

Features :

- Circular Dry Bar Table
- Flush flat Disc Base
- E0 Enviroboard Top
- Adjustable Levelling Feet
- Mix and Match top and base colours

Top Options :



Base Options :

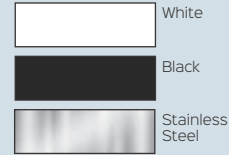

ETERNITY HIGH BAR TABLE

Specifications :

Top Size	• D-EHBT1575 - 1500W x 750D
Options	• D-EHBT1875 - 1800W x 750D
	• D-EHBT189 - 1800W x 900D
Table Height	1050mm

Features :

- Bar height
- Stylish angled leg, matches with Eternity range
- Dual support rails for added stability
- Adjustable feet
- E0 Melamine board table top

Top Options :

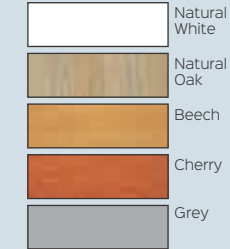

Base :

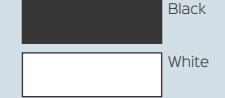

DRAFTING HEIGHT TABLE

Specifications :

Top Size	• 9SFT1575 - 1500W x 750D
	• 9SFT189 - 1800W x 900D
Table Height	900mm

Features :

- Drafting height table
- Powdercoated steel frame
- E0 Melamine board table top
- Adjustable feet

Top Options :

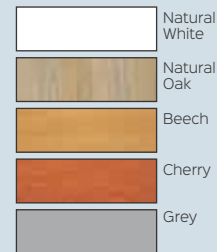

Base :

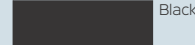

HIGH BAR TABLE - HBT189

Specifications :

Top Width	1800mm
Top Depth	900mm
Table Height	1050mm

Features :

- High bar table
- Powdercoated frame
- Cross bar foot rest
- Adjustable levelling feet
- E0 Melamine board table top

Top Options :

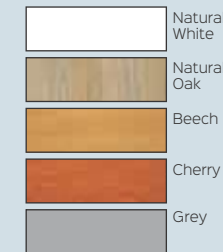

Base :



RAPID WORKER



RAPID WORKER CORNER WORKSTATION

Specifications :

Desk	• 1200 x 1200mm	• 1200 x 1500mm
Top	• 1200 x 1800mm	• 1200 x 2100mm
Size	• 1500 x 1500mm	• 1800 x 1500mm
	• 1800 x 1800mm	• 2100 x 1500mm
	• 2100 x 1800mm	• 2100 x 2100mm
Height	730mm	
Depth	600mm (or 750mm in 1800 x 1800mm)	

Features :

- 3-piece corner workstation

Finish Options :



Certifications :



*Beech / Ironstone
1500 x 1500mm



*Cherry / Ironstone
1800 x 1800mm



*Beech / Ironstone
1800 x 1800mm
Fixed pedestal sold separately

RAPID WORKER STRAIGHT DESK

Specifications :

Top	• CDK96 - 900W x 600D
Size	• CDK126 - 1200W x 600D
Options	• CDK1575 - 1500W x 750D • CDK1875 - 1800W x 750D • CDK189 - 1800W x 900D
Height	730mm

Finish Options :

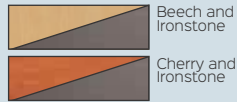

Certifications :



Features :

- E0 Melamine board
- CDK96 with 1 Cable entry hole only



RAPID WORKER DESK RETURN

Specifications :

Desk	• CR45 - 900W x 450D
Return	• CR6 - 900W x 600D
Size	• CR12 - 1200W x 600D
Height	730mm

Finish Options :

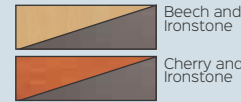

Certifications :



Features :

- E0 Melamine board
- Add to straight desk to create a corner
- Creates more desk top space
- Includes modesty panel piece



RAPID WORKER HUTCH

Specifications :

Width	• CH12 - 1200mm • CH15 - 1500mm • CH18 - 1800mm
Depth	315mm
Height	1070mm

Finish Options :

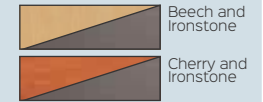

Certifications :



Features :

- 4 shelves in 1200mm and 1500mm sizes
- 6 shelves in 1800mm size
- E0 Melamine board



RAPID WORKER FIXED PEDESTAL

Specifications :

CDKPID1F	1 Drawer and 1 File Drawer 465W x 447D x 454H
CDKP3D	3 Drawers 465W x 447D x 454H
CRP3D	3 Drawers (For Return) 465W x 370D x 454H

Finish Options :

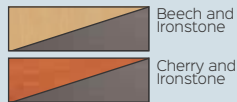

Certifications :



Features :

- E0 Melamine board
- Lockable, 2 keys supplied



RAPID WORKER MOBILE PEDESTAL

Specifications :

CMP2F	2 Drawers
CMP2D1F	2 Drawers and 1 File Drawer
CMP4D	4 Drawers
CMP2D1F-I	2 Drawers and 1 File Drawer (Ironstone Only)

Finish Options :

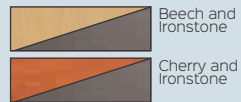

Certifications :



Features :

- E0 Melamine board
- All types 447 x 465 x 690mm



RAPID WORKER DESK HOB

Specifications :

Top Size	• CHOB15N - 1500W x 350D • CHOB18N - 1800W x 350D
Height	400mm

Finish Options :

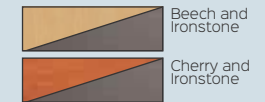

Certifications :



Features :

- E0 Melamine board
- Straight edge hob
- Creates a reception counter or privacy for your straight or corner desk



CUPBOARD - CSC2FD

Specifications :

Width	900mm
Depth	450mm
Height	1800mm

Features :

- E0 Melamine board
- 1 x fixed middle shelf
- 3 x adjustable shelves
- Fully lockable with 2 keys included

Finish Options :

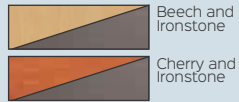

Certifications :



BOOKCASE

Specifications :

Height	• CBC9 - 900mm • CBC12 - 1200mm • CBC18 - 1800mm
Width	900mm
Depth	315mm

Features :

- E0 Melamine board
- 3 x adjustable shelves in 900 and 1200 H
- 4 x adjustable shelves in 1800 H

Finish Options :

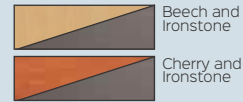

Certifications :



LOCKABLE WALL UNIT - CSC2HD

Specifications :

Width	900mm
Depth	450mm
Height	1800mm

Features :

- E0 Melamine board
- 2 adjustable shelves
- Lockable half height storage cupboard
- Supplied with 2 keys

Finish Options :

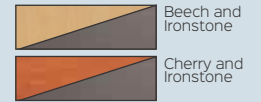

Certifications :



CREDENZA

Specifications :

Width	• CMZ1245 - 1200mm • CMZ1545 - 1500mm • CMZ1845 - 1800mm
Depth	450mm
Height	730mm

Features :

- E0 Melamine board
- 2 x adjustable shelves
- Fully lockable sliding door with 2 keys

Finish Options :

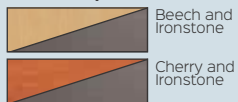

Certifications :



PIGEON HOLE UNIT - PH20

Specifications :

Width	1040mm
Depth	380mm
Height	1040mm

Features :

- E0 Melamine board
- Melamine pigeon hole unit
- 20 slots
- Adjustable shelves

Finish Options :

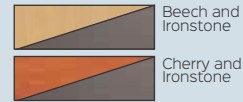

Certifications :



FILING CABINET

Specifications :

Width	465mm
Depth	600mm
Height	• C3FC - 998mm • C4FC - 1300mm

Features :

- E0 Melamine board
- Melamine 3 or 4 drawer filing cabinet
- Lockable, supplied with 2 keys
- Metal runner arms

Finish Options :

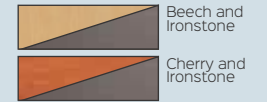

Certifications :





RAPID VIBE LAPTOP DESK - CDK96

Specifications :

Width	900mm
Depth	600mm
Height	730mm

Finish Options :

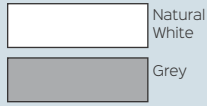

Features :

- E0 Melamine open desk
- Compact size for laptop or hot desk
- Matching under desk modesty panel

Certifications :

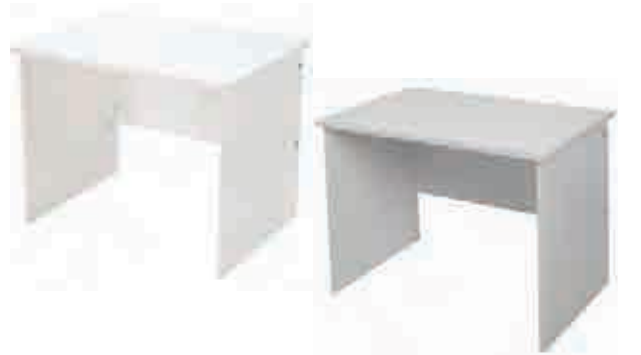

RAPID VIBE OPEN DESK

Specifications :

Top Size	• CDK1575 - 1500W x 750D
Options	• CDK189 - 1800W x 900D
Height	730mm

Finish Options :

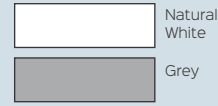

Features :

- E0 Melamine open desk
- Matching under desk modesty panel
- Use with Desk Return for more workspace and to create a corner workstation

Certifications :



RAPID VIBE DESK RETURN - CR6

Specifications :

Width	900mm
Depth	600mm
Height	730mm

Finish Options :

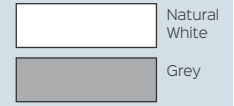

Features :

- E0 Melamine return
- Fix to any straight desk
- Create a corner shaped workstation
- Extra desk top space

Certifications :



VIBE HOME OFFICE DESK - CDK126

Specifications :

Desk Top Size	1200W x 600D
Desk Height	730mm
Drawer - HDKPID	465 x 447 x 152mm

Finish Options :

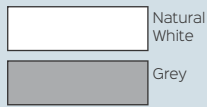

Features :

- E0 Melamine open desk
- Matching under desk modesty panel
- *Drawer sold separately - available in white only

Certifications :



RAPID VIBE CORNER WORKSTATION - CWS1818

Specifications :

Overall Width	1800mm x 1800mm
Top Depth	600mm
Height	730mm

Finish Options :

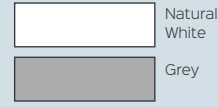

Features :

- E0 Melamine board
- 3 Piece corner workstation
- Under desk modesty panels
- Available in white and grey finishes

Certifications :



RAPID VIBE DESK HOB - CHOB18N

Specifications :

Width	1800mm
Depth	350mm
Height	400mm

Finish Options :



Features :

- Straight edge hob
- Use on straight or corner desk
- Creates a reception counter
- Add privacy to a desk
- E0 Melamine board

Certifications :



RAPID VIBE CUPBOARD - SP2FD18

Specifications :

Width	900mm
Depth	450mm
Height	1800mm

Features :

- Full door cupboard
- 1 x fixed mid shelf
- 3 x adjustable shelves
- Fully lockable with 2 keys included
- E0 Melamine board

Finish Options :

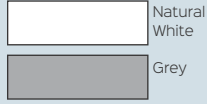

Certifications :



RAPID VIBE BOOKCASE

Specifications :

Width	900mm
Depth	315mm
Height	• SPBC12 - 1200mm • SPBC18 - 1800mm

Features :

- Open bookcase
- 1200mm H with 3 x adjustable shelves
- 1800mm H with 4 x adjustable shelves
- E0 Melamine board

Finish Options :

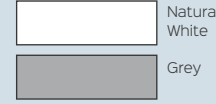

Certifications :



RAPID VIBE CREDENZA

Specifications :

Width	• SPC12 - 1200mm • SPC18 - 1800mm
Depth	450mm
Height	730mm

Features :

- Sliding door credenza
- 2 x adjustable shelves.
- Fully lockable with 2 keys included
- E0 Melamine board

Finish Options :



Certifications :



RAPID VIBE HUTCH

Specifications :

Width	• SPH12 - 1200mm • SPH18 - 1800mm
Depth	315mm
Height	1070mm

Features :

- Includes adjustable shelves
- 1200mm W with 2 vertical sections
- 1800mm W with 3 vertical sections
- E0 Melamine board

Finish Options :

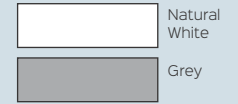

Certifications :



RAPID VIBE PEDESTALS

Specifications :

CDKP3D Fixed Pedestal	465W x 447D x 454H 3 Drawers
SPMP3 Mobile Pedestal	447W x 465D x 690H 2 Drawers and 1 File

Features :

- Lockable with 2 keys supplied
- Metal runners
- Fifth wheel for stability in Mobile Pedestal
- Silver handles
- E0 Melamine board

Finish Options :



Certifications :





RAPID MANAGER OPEN DESK

Specifications :

Width	• VDK1575 - 1500mm • VDK1875 - 1800mm
Depth	750mm
Height	730mm

Features :

- E0 Melamine board all over
- Melamine open desk
- Full modesty panel to floor
- *Drawers sold seperately

Finish Options :



Appletree and Ironstone

Certifications :



RAPID MANAGER METAL LEG DESK

Specifications :

Width	• VDKMB1575 - 1500mm • VDKMB1875 - 1800mm
Depth	750mm
Height	730mm

Features :

- Melamine top with 2 cable entry holes
- Metal span leg base
- Perforated modesty panel
- E0 Melamine board top

Finish Options :



Appletree and Black

Certifications :



RAPID MANAGER DESK HOB - VHOB18N

Specifications :

Width	1800mm
Depth	350mm
Height	400mm

Features :

- E0 Melamine board all over
- Curved edge hob for use on straight desk or corner workstation
- Create a reception or add privacy to a desk

Finish Options :



Appletree and Ironstone

Certifications :



MANAGER CORNER WORKSTATION - VCW186

Specifications :

Width	1800 x 1800mm
Depth	600mm
Height	730mm

Features :

- E0 Melamine board all over
- 1 piece top with Cable entry hole
- Full modesty panel to floor
- Melamine 3-piece base

Finish Options :



Appletree and Ironstone

Certifications :



MANAGER METAL CORNER - VCWMB186

Specifications :

Width	1800 x 1800mm
Depth	700mm
Height	730mm

Features :

- 1 Piece top with cable entry hole
- Metal span leg base
- Perforated modesty panels
- E0 Melamine board top

Finish Options :

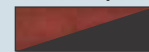

Appletree and Black

Certifications :



RAPID MANAGER HUTCH - VH18

Specifications :

Width	1800mm
Depth	380mm
Height	1050mm

Features :

- E0 Melamine board all over
- Storage hutch, use on desk or credenza
- Includes 4 cupboard spaces
- Includes 6 shelf spaces

Finish Options :



Appletree and Ironstone

Certifications :



CUPBOARD - VSC2FD

Specifications :

Width	900mm
Depth	450mm
Height	1800mm

Features :

- E0 Melamine board all over
- Full door cupboard
- 1 x fixed mid shelf
- 3 x adjustable shelves
- Fully lockable with 2 keys included

Finish Options :

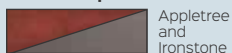

Appletree and Ironstone

Certifications :



Traditional dark wood finish with ironstone or black frames for desking, 25mm thickness all over. Matching storage for a classic, executive style.

BOOKCASE - VBC18

Specifications :

Width	900mm
Depth	315mm
Height	1800mm

Features :

- E0 Melamine board all over
- Open bookcase
- 4 adjustable shelves

Finish Options :

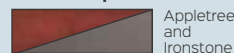

Appletree and Ironstone

Certifications :



CREENZA

Specifications :

Width	• VCZ1245 - 1200mm • VCZ1845 - 1800mm
Depth	450mm
Height	730mm

Features :

- E0 Melamine board all over
- Sliding door lockable credenza
- 2 x adjustable shelves.
- Fully lockable with 2 keys included

Finish Options :

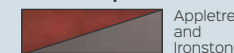

Appletree and Ironstone

Certifications :



FILING CABINET - V4FC

Specifications :

Width	465mm
Depth	600mm
Height	1300mm

Features :

- E0 Melamine board all over
- Lockable with 2 keys supplied

Finish Options :



Appletree and Ironstone

Certifications :



PEDESTALS

Specifications :

VDKP1D1F	Fixed - 1 Drawer and 1 File Drawer (Use With Ironstone Base Desk)
VDKP3D	Fixed - 3 Drawers (Use With Ironstone Base Desk)
VMP2D1F	Mobile Pedestal - 2 Drawers and 1 File Drawer

Features :

- E0 Melamine board all over
- Lockable with 2 keys supplied

Finish Options :

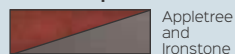

Appletree and Ironstone

Certifications :





MESH CHAIRS

MOTION CHAIR - MMC BG

Specifications :

Overall Size	960 - 1050H x 650W x 560D
Seat Size	520W x 510D
Gas Height	440 - 530H
Weight Rating	135kg

Features :

- Donati-dopo weight sensitive mechanism
- Seat slide, lumbar cushion, height adjustable
- 3D adjustable arms
- Head rest available with lead time

Certifications :



LUMINOUS TASK - LUMINOUS

Specifications :

Overall Size	960 - 1030H x 625W x 500D
Seat Size	480W x 545D
Gas Height	420 - 510H
Weight Rating	135kg

Features :

- High back black mesh executive chair
- Synchro mechanism, adjustable arms
- Height adjustable
- Head rest and hanger available with lead time

Certifications :



KAL TASK - KAL

Specifications :

Overall Size	970 - 1030H x 650W x 530D
Seat Size	500W x 510D
Gas Height	430 - 520H
Weight Rating	135kg

Features :

- Lumbar support, synchro mechanism
- Tension control and adjustable arms
- Height adjustable
- Head rest available with lead time

Certifications :



ERGO CHAIR - ERGO TASK

Specifications :

Overall Height	950 - 1040H x 520W x 540D
Seat Size	520W x 490D
Gas Height	450 - 540H
Weight Rating	165kg

Features :

- Fully ergonomic black mesh back chair
- Seat slide and ratchet back
- Suitable for heavy duty use
- Height adjustable

Certifications :



HARTLEY CHAIR - HARTLEY TASK

Specifications :

Overall Height	950 - 1015H x 630W x 500D
Seat Size	500W x 480D
Gas Height	440 - 520H
Weight Rating	110kg

Features :

- Synchro mechanism with tension control
- Moulded foam seat, black mesh back
- Adjustable arms, adjustable height
- Head rest available with lead time

Certifications :



GESTURE - GTC BK

Specifications :

Overall Size	955 - 1045H x 660W x 550D
Seat Size	480W x 520D
Gas Height	450 - 540H
Weight Rating	130kg

Features :

- Synchro-dynamic mechanism, seat slide
- Synchronised back rest and seat pan tilt
- Adjustable arms and height
- Head rest available with lead time

Certifications :



AM100 CHAIR - AM100

Specifications :

Overall Size	990 - 1080H x 650W x 610D
Seat Size	470W x 490D
Gas Height	460 - 550
Weight Rating	120kg

Finishes :

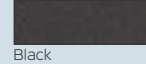

Black

Certifications :



Features :

- Seat and Back tilt
- Curved black mesh back, black fabric seat
- Adjustable arms
- Height Adjustable



AM200 CHAIR - AM200

Specifications :

Overall Size	1010 - 1110H x 660W x 650D
Seat Size	520W x 500D
Gas Height	420 - 520H
Weight Rating	120kg

Finishes :



Black Fabric /
Aluminium Base

Certifications :



Features :

- Medium black mesh back with fabric seat
- Infinite lock tilt, adjustable arms
- Polished aluminium base
- Height adjustable



VESTA CHAIR - VESTA

Specifications :

Overall Size	870 - 970H x 630W x 630D
Seat Size	460W x 460D
Gas Height	430 - 530H
Weight Rating	90kg

Finishes :

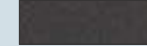

Black

Certifications :



Features :

- Black mesh back chair
- Single Point lock
- Height adjustable
- Fixed arms



EM300 CHAIR - EM300

Specifications :

Overall Size	920 - 1050H x 480W x 525D
Seat Size	490W x 440D
Gas Height	460 - 590H
Weight Rating	110kg

Finish Options :

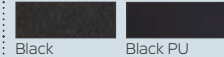

Black

Black PU

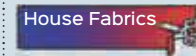

Certifications :



Features :

- Fully ergonomic, height adjustable
- Seat available in fabric or PU
- Mesh back with Injection moulded foam seat
- Arms, Chrome base and Drafting kit available for extra



ZOOM CHAIR - ZOOM | ZOOM TABLET

Specifications :

Overall Size	820H x 625W x 590D
Seat Size	490H x 460W x 490D
*Tablet Overall	20H x 420W x 280D
Weight Rating	110kg

Finishes :



Black Fabric



Certifications :



Features :

- Mesh back with fabric seat
- Foldable, can be nested when not in use
- *Tablet sold separately
- Seat upholstered in house fabrics for extra



VIENNA CHAIR - VIENNA

Specifications :

Overall Size	980 - 1100H x 610W x 610D
Seat Size	490W x 490D
Gas Height	430 - 550H
Weight Rating	100kg

Finishes :



Black

Red



Blue

Lime

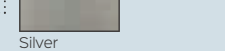

Silver

Certifications :



Features :

- Mesh back chair
- Tilt lock mechanism
- Height adjustable
- Fixed loop arms



MEETING CHAIRS

WM600 CHAIR - WM600

Specifications :

Overall Size	900 - 1020H x 580W x 530D
Seat Size	510W x 420D
Gas Height	480 - 590H
Weight Rating	120kg

Finishes :



Black Mesh /
Aluminium Base

Certifications :



Features :

- Ideal meeting chair
- Polished aluminium base and arms
- Single point tilt lock
- Height adjustable



FOCAL TUB - FOCAL

Specifications :

Overall Size	785H x 570W x 540D
Seat Size	450H x 370W x 380D
Weight Rating	110kg

Finishes :



Charcoal Ash
Fabric / Black Base

Certifications :



Features :

- Polypropylene inner shell with foam overlay
- Fixed height
- Powdercoated 4 star base
- Fabric upholstery



PIXEL CHAIR - PIXEL

Specifications :

Overall Size	850H x 485W x 600D
Seat Size	430H x 480W x 460D
Weight Rating	110kg

Finishes :



Grey Fabric / Black
Frame

Certifications :



Features :

- Ribbed stitching detail
- Solid timber inner frame with foam overlay
- Fixed height, swivel, 4 star base
- *Arms available for additional cost



VIVA CHAIR - VIVA

Specifications :

Overall Size	775 - 875H x 475W x 460W
Seat Size	455W x 430D
Gas Height	425 - 515H
Weight Rating	110kg

Finishes :



Black PU / White
Frame

Certifications :



Features :

- Stylish white polypropylene shell
- Black PU seat pad
- Height adjustable
- White base with black castors



RE100 CHAIR - RE100

Specifications :

Overall Size	1020 - 1140H x 510W x 500W
Seat Size	510W x 500D
Gas Height	470 - 590H
Weight Rating	110kg

Finishes :



Black Plastic / Black
Fabric

Certifications :



Features :

- Plastic perforated back with fixed arms
- Single point tilt lock
- Height adjustable
- Black base with black castors



PU605 MEDIUM - PU605M

Specifications :

Overall Size	980 - 1030H x 580W x 510D
Seat Size	485W x 460D
Gas Height	490 - 610H
Weight Rating	120kg

Finishes :



Certifications :



Features :

- Medium back black PU executive chair
- Polished aluminium base
- Chrome arms and frame
- Infinite lock, height adjustable



PU605 HIGH - PU605H

Specifications :

Overall Size	1105 - 1240H x 580W x 510D
Seat Size	485W x 460D
Gas Height	490 - 610H
Weight Rating	120kg

Finishes :



Certifications :



Features :

- High back black PU executive chair
- Infinite lock, Height adjustable
- Polished aluminium base
- Fixed chrome arms



SWIFT CHAIR - SWIFT BL

Specifications :

Overall Size	990 - 1090H x 630W x 500D
Seat Size	540W x 450D
Gas Height	510 - 590H
Weight Rating	130kg

Finishes :



Certifications :



Features :

- High back black fabric chair
- Infinite tilt lock, Height adjustable
- Polished aluminium spider base
- Adjustable arms



PU900 MEDIUM - PU900M

Specifications :

Overall Size	890 - 960H x 580W x 530D
Seat Size	520W x 435D
Gas Height	460 - 545H
Weight Rating	120kg

Finishes :



Certifications :



Features :

- Medium back upholstered in Black PU
- Single point lock, height adjustable
- Polished aluminium base
- Fixed arms



PU900 HIGH - PU900H

Specifications :

Overall Size	1050 - 1135H x 585W x 530D
Seat Size	500W x 415D
Gas Height	460 - 550H
Weight Rating	120kg

Finishes :



Certifications :



Features :

- High back upholstered in Black PU
- Single point lock, height adjustable
- Polished aluminium base
- Fixed arms



EXECUTIVE CHAIRS

PU300 CHAIR - PU300

Specifications :

Overall Size	1090 - 1170H x 670W x 640D
Seat Size	540W x 450D
Gas Height	510 - 590H
Weight Rating	130kg

Finishes :



Black PU / Chrome Frame

Certifications :



Features :

- Fully ergonomic soft black pu chair
- Ratchet back, seat slide, height adjustable
- Chrome base
- Adjustable arms



CL410 CHAIR - CL410

Specifications :

Overall Size	1190 - 1290H x 650W 720D
Seat Size	540W x 500D
Gas Height	450 - 550H
Weight Rating	120kg

Finishes :



Black PU / Chrome Frame

Certifications :



Features :

- Soft black PU upholstery with fabric inlay
- Infinite tilt lock, height adjustable
- Fixed curved arm rests
- Chrome base



CL610 CHAIR - CL610

Specifications :

Overall Size	1010 - 1140H x 620W x 680D
Seat Size	495W x 500D
Gas Height	450 - 580H
Weight Rating	120kg

Finishes :

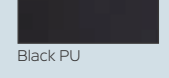

Black PU

Certifications :



Features :

- Soft black PU upholstery
- Single point tilt lock, height adjustable
- Medium back
- Fixed curved arm rests



CL710 CHAIR - CL710

Specifications :

Overall Size	1230 - 1320H x 630W x 600D
Seat Size	530W x 530D
Gas Height	460 - 550H
Weight Rating	120kg

Finishes :

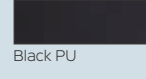

Black PU

Certifications :



Features :

- Soft black PU upholstery
- 4 point tilt lock, height adjustable
- High back executive chair
- Fixed curved armrests



CL820 CHAIR - CL820

Specifications :

Overall Size	1180 - 1250H x 670W x 740D
Seat Size	520W x 480D
Gas Height	420 - 490H
Weight Rating	130kg

Finishes :



Black PU / Chrome Frame

Certifications :



Features :

- Soft black PU upholstery
- Infinite tilt lock, height adjustable
- Fixed curved polished aluminium arms
- Chrome base



LUJO MEDIUM - LUJO-MB RB

Specifications :

Overall Size	1060 - 1140H x 630W x 510D
Seat Size	475W x 475D
Gas Height	450 - 540H
Weight Rating	120kg

Finishes :

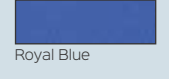

Royal Blue

Certifications :



Features :

- Medium back executive chair
- Built-in lumbar support
- High grade synchro mechanism
- Flared arm rest design



PELLE HIGH BACK - PHB BL

Specifications :

Overall Size	1130 - 1250H x 615W x 580D
Seat Size	500W x 560D
Gas Height	425 - 540H
Weight Rating	130kg

Finishes :



Black PU /
Aluminium Frame

Certifications :



Features :

- High back executive chair in black PU leather
- Seat and back tilt with multi-lock
- Polished aluminium 5 star spider base
- Height adjustable



PELLE MEDIUM BACK - PMB BL

Specifications :

Overall Size	975 - 1100H x 615W x 580D
Seat Size	500W x 560D
Gas Height	425 - 540H
Weight Rating	130kg

Finishes :



Black PU /
Aluminium Frame

Certifications :



Features :

- Medium back chair in black PU leather
- Seat and back tilt with multi-lock
- Polished aluminium 5 star spider base
- Height adjustable



PELLE VISITOR CHAIR - PVM BL

Specifications :

Overall Size	975H x 615W x 580D
Seat Size	425H x 500W x 560D
Weight Rating	130kg

Finishes :



Black PU /
Aluminium Frame

Certifications :



Features :

- Medium back executive visitor chair
- Black PU leather
- Polished aluminium cantilever base
- Fixed arm rests



CL3000 HIGH BACK - CL3000H

Specifications :

Overall Size	1200 - 1320H x 620W x 540D
Seat Size	505W x 510D
Gas Height	440 - 560H
Weight Rating	120kg

Finishes :



Black PU /
Aluminium Frame

Certifications :



Features :

- High back slimline black PU leather executive chair
- Seat and back tilt, height adjustable
- 3-position lock mechanism with anti shock
- Fixed arm rests



CL3000 MEDIUM BACK - CL3000M

Specifications :

Overall Size	1000 - 1130H x 620W x 555D
Seat Size	505W x 510D
Gas Height	440 - 560H
Weight Rating	120kg

Finishes :



Black PU /
Aluminium Frame

Certifications :



Features :

- Medium back slimline black pu leather executive chair
- Seat and back tilt, height adjustable
- 3-position lock mechanism with anti shock
- Fixed arm rests



CL3000 VISITOR - CL3000V

Specifications :

Overall Size	1000H x 590W x 540D
Seat Size	460H x 510W x 510D
Weight Rating	120kg

Finishes :



Black PU /
Aluminium Frame

Certifications :



Features :

- Slimline executive visitor chair
- Soft black PU leather seat and back
- Fixed, chrome upholstered arms
- Cantilever base



OPERATOR CHAIRS

EC070CM CHAIR - EC070CM

Specifications :

Overall Size	900 - 1030H x 500W x 450D
Seat Size	500W x 450D
Gas Height	470 - 600H
Weight Rating	120kg

Finish Options :



House Fabrics



Features :

- AFRDI level 6
- Fully ergonomic medium back fabric chair
- injection moulded foam seat
- Seat and back tilt with gas lift



EC070BM CHAIR - EC070BM

Specifications :

Overall Size	900 - 1030H x 500W x 450D
Seat Size	500W x 450D
Gas Height	470 - 600H
Weight Rating	120kg

Finish Options :

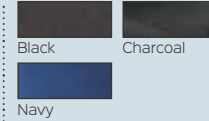

Certifications :



Features :

- AFRDI level 6
- Medium back fabric chair
- Back tilt, gas lift
- injection moulded foam seat



EC070BM DRAFTING - EC070BM DRAFTING

Specifications :

Overall Size	1060 - 1230H x 500W x 450D
Seat Size	500W x 450D
Gas Height	630 - 800H
Weight Rating	120kg

Finishes :

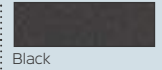

Certifications :



Features :

- Medium back drafting chair
- Back tilt, gas lift
- injection moulded foam



EC070BH CHAIR - EC070BH

Specifications :

Overall Size	990 - 1120H x 500W x 450D
Seat Size	500W x 450D
Gas Height	470 - 600H
Weight Rating	120kg

Finish Options :

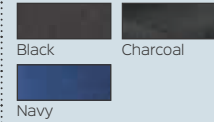

Certifications :



Features :

- High back chair
- Gas lift, back tilt
- Injection moulded foam



EC070CH CHAIR - EC070CH

Specifications :

Overall Size	990 - 1120H x 500W x 450D
Seat Size	500W x 450D
Gas Height	470 - 600H
Weight Rating	120kg

Finish Options :

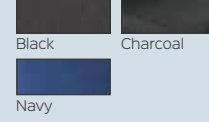

Certifications :



Features :

- Fully ergonomic high back fabric chair
- injection moulded foam seat
- Seat and back tilt with gas lift



ET20 CHAIR - ET20

Specifications :

Overall Size	830 - 940H x 480W x 460D
Seat Size	480W x 460D
Gas Height	420 - 530H
Weight Rating	100kg

Finishes :

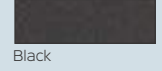

Certifications :



Features :

- Black fabric medium back chair
- Gas lift, back and seat tilt
- Injection moulded foam



EG100CH CHAIR - EG100

Specifications :

Overall Size	1010 - 1150H x 520W x 480D
Seat Size	520W x 480D
Gas Height	480 - 620H
Weight Rating	130kg

Finish Options :

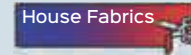
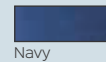

Features :

- AFRDI level 6
- Fully ergonomic high back fabric chair
- injection moulded foam seat
- Seat and back tilt with gas lift



PO500 CHAIR - PO500

Specifications :

Overall Size	1020 - 1150H x 550W x 570D
Seat Size	530W x 510D
Gas Height	490 - 590H
Weight Rating	150kg

Finish Options :

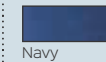

Features :

- AFRDI level 6, heavy duty mechanism
- Fully ergonomic high back fabric chair
- injection moulded foam, extra large seat
- Seat and back tilt with gas lift



EG400 CHAIR - EG400

Specifications :

Overall Size	960 - 1080H x 510W x 520D
Seat Size	520W x 480D
Gas Height	480 - 620H
Weight Rating	130kg

Finish Options :

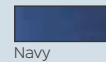

Features :

- AFRDI level 6
- Fully ergonomic high, square back, fabric chair
- injection moulded foam seat
- Seat and back tilt with gas lift



CHAIR MATS

Specifications :

MAT S - Small Dimpled	915W x 1200D x 2T
MAT L - Large Dimpled	1150W x 1350D x 2T
MAT SM S - Small Smooth	915W x 1200D x 2T
MAT SM L - Large Smooth	1150W x 1350D x 2T

Finish :



Clear

Certifications :



Features :

- Use smooth for hard floors
- Dimpled mats for low pile carpet floors
- Tested for fire retardancy



CHAIR ACCESSORIES

Suitable for

- ECO70CM
- ECO70BM
- ECO70CH
- ECO70BH
- EG100CH
- EG400
- PO500
- ET20

Certifications :



ADJUSTABLE ARMS - ADJ ARMS

Specifications :

Overall Size	250 - 320H x 230W x 260D
--------------	--------------------------

Finish :

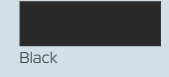

Black

Features :

- Adjustable height
- 85W x 260D soft arm pad



CHROME BASE - CH BASE

Specifications :

Overall Size	150H x 650 Dia.
--------------	-----------------

Finish :



Chrome

Features :

- Polished Aluminium
- Stylish and up market



DRAFTNG KIT - DRAFTNG KIT

Specifications :

Overall Size	150H x 650 Diameter
--------------	---------------------

Finish :



Chrome / Black

Features :

- Create a drafting height chair



BREAKOUT AND VISITOR CHAIRS

HARTLEY VISITOR - HARTLEY VISITOR

Specifications :

Overall Size	950H x 645W x 480D
Seat Size	440H x 510W x 480D
Weight Rating	135kg

Finish Options :

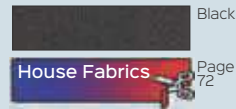

Features :

- Black cantilever frame
- Adjustable arms and mesh back
- Comfortable padded fabric seat
- Matches with Hartley Task Chair

Certifications :



*Pebble House Fabric



*Standard Black

WMCC CHAIR - WMCC

Specifications :

Overall Size	940H x 625W x 620D
Seat Size	440H x 470W x 470D
Weight Rating	120kg

Finish Options :

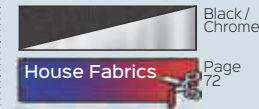

Features :

- Cantilever chrome base
- Comfortable mesh material on back
- Fixed Arms
- Fabric seat

Certifications :



*Standard Black



*Carbon House Fabric

WMVBK CHAIR - WMVBK

Specifications :

Overall Size	890H x 570W x 460D
Seat Size	480H x 480W x 480D
Weight Rating	120kg

Finish Options :

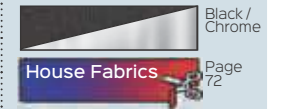

Features :

- Mesh back and fabric seat
- Chrome frame and legs
- Curved plastic arm rests
- Seat can be upholstered in house fabrics

Certifications :



*Standard Black



*Navy House Fabric

V100 CHAIR - V100

Specifications :

Overall Size	800H x 500W x 450D
Seat Size	460H x 450W x 450D
Weight Rating	120kg

Finishes :

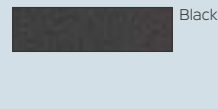

Features :

- Comfortable black fabric
- Black frame
- Stackable

Certifications :



WFV100 CHAIR - WFV100 BL

Specifications :

Overall Size	930H x 570W x 580D
Seat Size	475H x 450W x 435D
Weight Rating	120kg

Finishes :

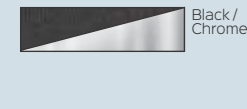

Features :

- Comfortable black fabric chair
- Chrome sled base
- Modern and stylish design
- Linkable bases

Certifications :



NOVA CHAIR - NOVA

Specifications :

Overall Size	780H x 540W x 460D
Seat Size	445H x 448W x 444D
Weight Rating	110kg

Finish Options :



Features :

- Stackable
- Linkable
- Fabric seat and back
- Black powdercoated frame



P100 CHAIR - P100

Specifications :

Overall Size	845H x 450W x 370D
Seat Size	440H x 450W x 370D
Weight Rating	130kg

Finishes :

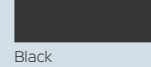

Certifications :



Features :

- Polypropylene plastic chair
- Stackable
- Sturdy frame
- Ventilation hole in back



DS DESK STOOL - DS DESK

Specifications :

Overall Size	450 - 570H x 600 Diameter
Seat Size	450 - 570H x 400 Diameter
Weight Rating	100kg

Finishes :



Certifications :



Features :

- 400mm round seat desk stool
- Easy to clean black pu material
- Black spider base
- Height adjustable



DS COUNTER STOOL - DS COUNTER

Specifications :

Overall Size	650 - 870H x 600 Diameter
Seat Size	650 - 870H x 400 Diameter
Weight Rating	100kg

Finishes :



Certifications :



Features :

- 400mm round seat counter stool
- Chrome drafting ring
- Easy to clean Black PU material
- Black spider base



FRAME CHAIR - FRAME BL

Specifications :

Overall Size	790H x 470W x 500D
Seat Size	455H x 420W x 410D
Weight Rating	120kg

Finishes :

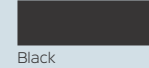

Certifications :



Features :

- Perforated back rest and polypropylene seat
- Stackable with linking feature
- Solid rod base
- SGS: EN12520 Certification



LAB CHAIR - LAB CH

Specifications :

Overall Size	845 - 960H x 470W x 430D
Seat Size	420 - 540H x 470W x 435D
Weight Rating	110kg

Finishes :

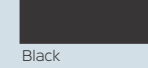

Certifications :



Features :

- Height adjustable Laboratory chair
- Moulded polyurethane
- Contoured waterfall seat pan
- Seat and back tilt



LAB STOOL - LAB ST

Specifications :

Overall Size	965 - 1185H x 470W x 500D
Seat Size	640 - 850H x 460W x 440D
Weight Rating	110kg

Finishes :



Certifications :



Features :

- Moulded polyurethane
- Contoured waterfall seat pan
- Tilting back rest with infinite lock
- Height adjustable, chrome drafting ring



BREAKOUT AND VISITOR CHAIRS

MAUI CHAIR - MAUI GB

Specifications :

Overall Size	840H x 530W x 460D
Seat Size	450H x 465W x 450D
Weight Rating	135kg

Finishes :



Features :

- Polypropylene chair
- White and Slate-Grey frame
- Grey fabric seat cover included
- Made from 100% recyclable materials

Certifications :



ALOHA CHAIR - ALOHA

Specifications :

Overall Size	825H x 480W x 470D
Seat Size	450H x 430W x 430D
Weight Rating	120kg

Chair Finish :

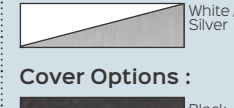

Cover Options :

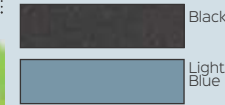

Features :

- Elastic polypropylene
- *Seat covers extra
- 2 year warranty on fabric seat covers
- Greenguard approved



COMFO CHAIR - COMFO

Specifications :

Overall Size	970H x 570W x 600D
Seat Size	460H x 510W x 490D
Weight Rating	110kg

Finishes :

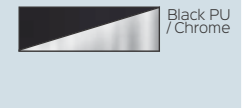

Features :

- Black PU leather seat and back
- Chrome cantilever base
- Padded curved arm rests

Certifications :



VIRGO CHAIR - VIRGO

Specifications :

Overall Size	825H x 440W x 440D
Seat Size	470H x 430W x 430D
Weight Rating	110kg

Finish Options :



Features :

- Timber leg
- Polypropylene shell
- Comfortable fabric seat pad

Certifications :



LEO CHAIR - LEO

Specifications :

Overall Size	830H x 460W x 410D
Seat Size	450H x 420W x 410D
Weight Rating	100kg

Finish Options :

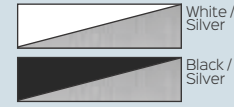

Features :

- Plastic hospitality chair
- Suitable for indoor or outdoor use
- Aluminium legs

Certifications :



FERNANDO CHAIR - FERNANDO

Specifications :

Overall Size	920H x 425W x 420D
Seat Size	440H x 425W x 420D
Weight Rating	90kg

Finishes :

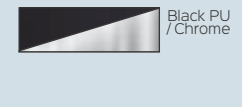

Features :

- Stylish black PU seat and back
- Chrome frame
- Cut out feature in back of chair
- Stackable

Certifications :



TAURUS CHAIR - TAURUS

Specifications :

Overall Size	735mm H x 540mm W x 460mm D
Seat Size	440mm H x 440mm W x 435mm D
Weight Rating	110kg

Features :

- Chrome frame and legs
- Wrap around polypropylene shell with back cut out feature
- Stackable
- Matching stool available

Finish Options :

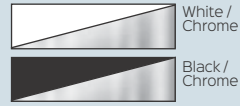

Certifications :



ARIES BAR STOOL - ARIES ST

Specifications :

Overall Size	853mm H x 455mm W x 545mm D
Seat Size	760mm H x 440mm W x 450mm D
Weight Rating	110kg

Features :

- Stylish black metal curved frame
- Polypropylene plastic seat pan
- Leg rest on base / frame

Finish Options :

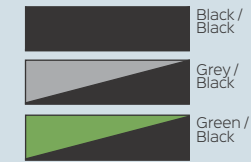

Certifications :



TAURUS BAR STOOL - TAURUS STOOL

Specifications :

Overall Size	1050mm H x 525mm W x 460mm D
Seat Size	750mm H x 435mm W x 455mm D
Weight Rating	110kg

Features :

- Chrome frame and legs
- Wrap around polypropylene shell with back cut out feature
- Leg rest on chrome base / frame
- Matching chair available

Finish Options :



Certifications :



VIRGO BAR STOOL - VIRGO ST

Specifications :

Overall Size	820mm H x 475mm W x 475mm D
Seat Size	770mm H x 440mm W x 450mm D
Weight Rating	110kg

Features :

- Modern bar stool
- Oak coloured frame
- Curved polypropylene plastic seat pan

Finish Options :

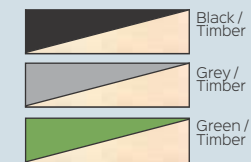

Certifications :



BREAKOUT AND VISITOR CHAIRS

LUCID CHAIR - LUCID

Specifications :

Overall Size	795H x 500W x 500D
Seat Size	445H x 440W x 400D
Weight Rating	110kg

Seat Finishes :

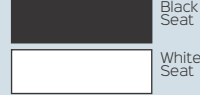

Features :

- Concealed Feet Buttons
- Polypropylene Chair
- Textured Seat and back
- Mix and Match seats and bases

Certifications :



Leg Finishes :



VIVID CHAIR - VIVID

Specifications :

Overall Size	820H x 455W x 510D
Seat Size	460H x 455W x 470D
Weight Rating	120kg

Finishes :

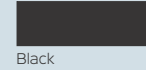

Features :

- Large polypropylene shell seat
- Powdercoated steel sled base
- Nylon glides under frame
- Stackable

Certifications :



PMVBK CHAIR - PMVBK

Specifications :

Overall Size	810H x 530W x 460D
Seat Size	450H x 455W x 460D
Weight Rating	110kg

Finishes :



Features :

- Black mesh back chair
- Plastic seat
- Stackable with linking feature
- Chrome sled base and frame

Certifications :



TEMPO CHAIR - TEMPO

Specifications :

Overall Size	820H x 550W x 570D
Seat Size	420H x 480W x 420D
Weight Rating	110kg

Finishes :

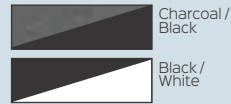

Features :

- Fabric Seat
- Powdercoat sled base
- Linking
- Stackable

Certifications :



ZING CHAIR - ZING

Specifications :

Overall Size	810H x 465W x 430D
Seat Size	440H x 465W x 430D
Weight Rating	120kg

Finish Options :



Features :

- Large plastic back and seat
- Linkable and Stackable
- Chrome sled base with feet
- Seat and back pads available in house fabric colours for extra

Certifications :



PIPPEE CHAIR - PIPPEE

Specifications :

Overall Size	860H x 400W x 380D
Seat Size	450H x 400W x 380D
Weight Rating	150kg

Finish Options :

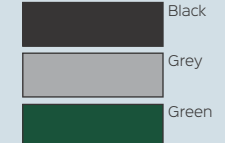

Features :

- Polypropylene plastic
- Stackable
- High luster shine
- Holds up to 150kg under intended use

Certifications :



WIMBLEDON CHAIR - WIMBLEDON

Specifications :

Overall Size	785H x 435W x 460D
Seat Size	440H x 425W x 430D
Weight Rating	120kg

Finish Options :



Black / Chrome

Features :

- Plastic seat and back
- Chrome sled base
- Linkable and Stackable
- SGS: EN12520 Certification

Certifications :



*Linked Wimbledon Side chairs shown with arms, middle without.

WIMBLEDON WITH ARMS - WIMBLEDON WITH ARMS

Specifications :

Arms	205H x 30W x 285D
Weight Rating	120kg

Finish Options :



Black / Chrome

Features :

- Plastic seat and back with arms
- Chrome sled base
- Linkable
- Stackable

Certifications :



WIMBLEDON TABLET - WTAB

Specifications :

Tablet	255W x 395D
Height from seat	215mm

Finish Options :



Black / Chrome

Features :

- Plastic seat and back
- Chrome sled base
- Foldable Tablet

Certifications :



WIMBLEDON PADS - WSP | WBP

Specifications :

Seat Size	440H x 425W x 430D
Back Size	245H x 455W
Weight Rating	120kg

Finish Options :

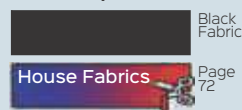

Black Fabric

House Fabrics Page 72

Features :

- Stocked in black fabric
- Can be upholstered in house fabrics
- Seat pad - WSP sold separately
- Back pad - WBP sold separately

Certifications :



*Standard Black

*Ink House Fabric

ZOLA CHAIR - ZOLA

Specifications :

Overall Size	800H x 460W x 500D
Seat Size	430H x 460W x 440D
Weight Rating	100kg

Finish Options :



Black / Chrome

Features :

- Black plastic seat
- Curved back
- Chrome frame with sled base
- Stackable

Certifications :



CHAIR TROLLEY - Z TROLLEY

Specifications :

Overall Size	440 H x 800W x 620 D
Weight Rating	Maximum of 30 chairs
Compatible with	<ul style="list-style-type: none"> • PMVBK • FRAME BL • ZING • ZOLA • WIMBLEDON

Finishes :

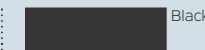

Black

Certifications :



HOUSE FABRICS

Chair and Screen Upholstery

For a wider colour selection than our standard express range, we can upholster certain products in a range of extended house fabrics, or *your fabric of choice.

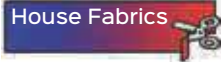

UPHOLSTERY CHAIRS :

- EM300
- EC070CM
- EG100
- PO500
- MOTION
- GESTURE
- LUMINOUS
- ERGO
- HARTLEY TASK
- HARTLEY VISITOR
- KAL
- ZOOM
- WMCC
- WMVBK
- WIMBLEDON (Back and Seat Pad)
- CONNECT OTTOMAN
- MARS OTTOMANS
- ZING (Back and Seat Pad)

UPHOLSTERY SCREENS :

- SHUSH30
 - RAPID SCREEN
- (Fabric Top Half of Screen Panel)
- INFINITY/ETERNITY FABRIC SCREENS
 - FREESTANDING ACOUSTIC SCREENS



MIST

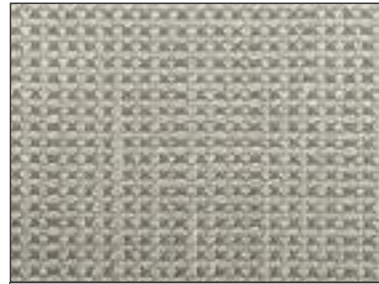

PUMICE



ESSENCE

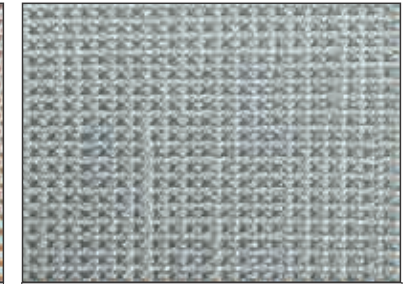

SEAFOAM



PEBBLE

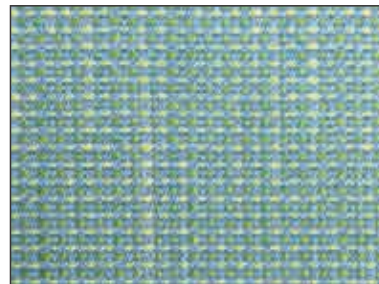

SPRAY



CASCADE

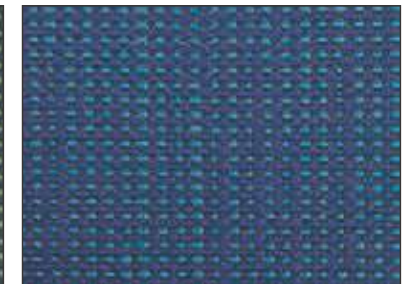

INK



STEEL



CARBON



MARINE



NAVY



ONYX

Lead Times and Additional Charges Apply
*Option to supply your own fabric

HAND SANITISING STATION - HSS1250 WS

Specifications :

Stand Size	1250H x 245D x 125W
Base Size	435W x 400D

Features :

- Easy to assemble, durable, sturdy
- Does not require main power or plumbing
- Powdercoated Drip Tray can be used as shelf for Pump Bottles of Sanitiser
- Easily mounted to floor or use as portable station
- Instruction label with adhesive back included

Finish :

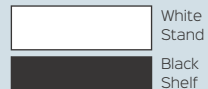

Certifications :



*Dispenser sold separately



AUTOMATIC DISPENSER - AHSLD WH

Specifications :

Overall Size	260H x 110W x 120D
Includes	1L Container

Features :

- Includes 1L Container - Easy to refill
- Gel Sanitiser refills available in cartons of 10 x 1L bottles (Not included)
- Gel dispenses approximately 1.33ml; approximately 750 dispenses per litre
- Requires 4 x C batteries (Batteries not included)

Finish Options :



Certifications :



ACRYLIC SCREENS

Specifications :

Size Options	<ul style="list-style-type: none"> • AS660 - 600H x 690W x 8T • AS1160 - 600H x 1180W x 8T • AS1460 - 600H x 1480W x 8T • AS1760 - 600H x 1780W x 8T
Feet	AS SCREEN FEET - Set of 2 100H x 120W x 68D

Features :

- Free standing when used with feet
- Remove at any time without damaging table

Finish Options :



Certifications :



DESK MOUNTED CLAMP - VSA

Specifications :

Clamp Size	59H x 33W x 42D
------------	-----------------

Features :

- Set of 2
- Desk mounted clamp
- Use with any size acrylic screens
- Holds screens from 8mm to 18mm thick

Finish Options :



Certifications :



SIDE MOUNTED CLAMP - VSB

Specifications :

Clamp Size	92H x 33W x 44D
------------	-----------------

Features :

- Set of 2
- Side mounted clamp
- Use with any size acrylic screens
- Holds screens from 8mm to 18mm thick

Finish Options :



Certifications :



BACK TO BACK CLAMP - VBC

Specifications :

Clamp Size	90H x 71W x 44D
------------	-----------------

Features :

- Set of 2
- Back to Back mounted clamp
- Use with any size acrylic screens
- Holds screens from 8mm to 18mm thick

Finish Options :



Certifications :





GLASSBOARD

Specifications :

Size Options	<ul style="list-style-type: none"> • GB96 - 900W x 600H • GB129 - 1200W x 900H • GB159 - 1500W x 900H • GB1512 - 1500W x 1200H • GB189 - 1800W x 900H • GB1812 - 1800W x 1200H • GB2112 - 2100W x 1200H • GB2412 - 2400W x 1200H
Overall Depth	15mm

Features :

- Compatible with any whiteboard markers or liquid chalk markers (not included)
- Super clear 4mm toughened glassboard
- Magnetic surface - Requires super strong magnets
- Galvanised steel backing
- 25mm chrome fittings

Finish :

White

Certifications :



LECTERN - LCT12 BL

Specifications :

Overall Size	1200H x 445W x 450D
Top Shelf Size	600W x 400D
Second Shelf Size	550W x 260D

Features :

- Heavy duty lectern
- Angled top shelf for presentations
- Second shelf for storage
- Black powdercoated finish
- Detachable adjustable battery powered LED light
- Castors

Finish :

Black

Certifications :



STANDARD WHITEBOARD

Specifications :

Size Options	• W96 - 900H x 600W • W1212 - 1200H x 1200W • W1512 - 1500H x 1200W • W1812 - 1800H x 1200W • W2112 - 2100H x 1200W	• W129 - 1200H x 900W • W159 - 1500H x 900W • W189 - 1800H x 900W • W219 - 2100H x 900W • W2412 - 2400H x 1200W
Overall Depth	15mm	

Features :

- Wall mounted aluminium framed
- Magnetic surface
- Pen tray included
- Concealed corner fixing
- Acrylic polyester resin
- Includes fixing screws



PORCELAIN WHITEBOARD

Specifications :

Size Options	• PWB96 - 900H x 600W • PWB1212 - 1200H x 1200W • PWB1512 - 1500H x 1200W • PWB1812 - 1800H x 1200W • PWB2412 - 2400H x 1200W • PWB3612 - 3600H x 1200W	• PWB129 - 1200H x 900W • PWB159 - 1500H x 900W • PWB189 - 1800H x 900W • PWB2112 - 2100H x 1200W • PWB3012 - 3000H x 1200W
Depth	15mm	

Features :

- Porcelain / Vitreous enamel surface (Polyvision E3 ceramic steel)
- Includes 4 x Magnets
- Includes fixing screws
- Includes pen tray



PINBOARD

Specifications :

Size Options	• PIN96 - 900W x 600H • PIN1212 - 1200W x 1200H • PIN1512 - 1500W x 1200H • PIN1812 - 1800W x 1200H	• PIN129 - 1200W x 900H • PIN159 - 1500W x 900H • PIN189 - 1800W x 900H • PIN2412 - 2400W x 1200H
Overall Depth	15mm	

Features :

- Wall mounted pinboard
- Concealed corner wall fixings
- Felt surface
- Includes 4 Pins
- Galvanised steel backing and a low density fibreboard core

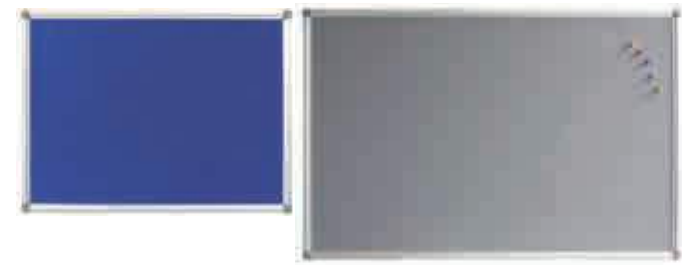
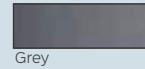
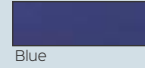

MOBILE WHITEBOARD

Specifications :

Board Size Options	• M129 - 1200W x 900H • M1512 - 1500W x 1200H • M1812 - 1800W x 1200H	• M159 - 1500W x 900H • M189 - 1800W x 900H
Overall Size	1770H x 550D	

Features :

- Double sided
- Pivoting
- Mobile whiteboard with castors
- Includes pen tray

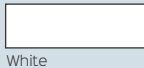

MOBILE PORCELAIN WHITEBOARD

Specifications :

Board Size Options	• PMW129 - 1200W x 900H • PMW1512 - 1500W x 1200H • PMW1812 - 1800W x 1200H
Overall Size	1770H x 550D

Features :

- Porcelain / Vitreous enamel surface (Polyvision E3 ceramic steel)
- Mobile whiteboard with castors
- Includes pen tray



CORKBOARD

Specifications :

Board Size Options	• C96 - 900W x 600H • C1212 - 1200W x 1200H • C1512 - 1500W x 1200H • C1812 - 1800W x 1200H	• C129 - 1200W x 900H • C159 - 1500W x 900H • C189 - 1800W x 900H • C2412 - 2400W x 1200H
Overall Depth	15mm	

Features :

- Composite corkboard aluminium frame
- Concealed corner wall fixings
- Suitable for pins or stickers

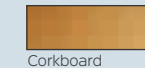

ECO SLIDE ON SCREEN - EPS60 BK

Specifications :

Overall Size 300H x 650W x 27T

Features :

- Slide on divider screen
- Pinnable surface
- Polyester eco friendly fibre
- Compatible with Deluxe rapid infinity, Rapid infinity, Rapid span, Rapid worker, Rapid vibe and Rapid manager ranges

Finishes :

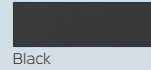

Black

Certifications :



ECO PANEL SCREEN

Specifications :

Size Options • EPS098 BK - 890W x 300H
• EPS119 BK - 1190W x 300H
• EPS149 BK - 1490W x 300H

Thickness 27mm

Features :

- Desk mounted screen with screw plate fixing
- Pinnable surface
- Polyester eco friendly fibre
- 3 clamps with 1490W size

Finishes :



Black / White clamps

Certifications :



CHAIR MATS

Specifications :

MAT S - Small Dimpled	915W x 1200D x 2T
MAT L - Large Dimpled	1150W x 1350D x 2T
MAT SM S - Small Smooth	915W x 1200D x 2T
MAT SM L - Large Smooth	1150W x 1350D x 2T

Features :

- Use smooth for hard floors
- Dimpled mats for low pile carpet floors
- Tested for fire retardancy

Finish :



Clear

Certifications :



ACOUSTIC SCREEN

Specifications :

Size Options • A1515 - 1500W x 1500H
• A1518 - 1500W x 1800H
• A1815 - 1800W x 1500H
• A1818 - 1800W x 1800H

Thickness 50mm

Features :

- Free standing dividing office panels
- Pinnable fabric with black pvc edging
- Silver freestanding feet

Finishes :

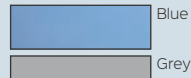

Blue

Grey

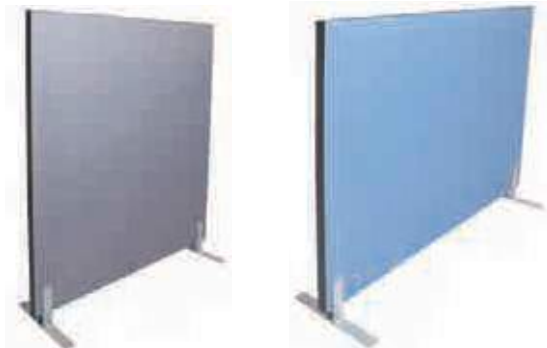
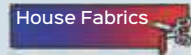

UTILITY TROLLEY - TR3

Specifications :

Overall Size 900H x 800W x 600D
Weight Rating 100kg

Features :

- Utility trolley
- 3 tiers of storage space
- Castor wheels for ease of movement
- Strong, sturdy frame

Finishes :



Ironstone

Certifications :



CORNER LOZENGE

Specifications :

Overall Size 250W x 480D
Height Options • LOZENGE25 - 25mm H
• LOZENGE33 - 33mm H

Features :

- Converts desk and return to a corner workstation
- Adds diagonal for user to sit at
- Fits 25mm or 33mm deep melamine tops

Finishes :



Graphite

Certifications :



GO STEEL SLIMLINE MOBILE PED - GSP3

Specifications :

Overall Size 610H x 300W x 472D

Features :

- Slimline for smaller workstations
- Lockable - Supplied with 2 keys
- Stores foolscap files side to side
- Flush drawer front
- Ball bearing runners
- Fifth wheel for stability
- Keyed alike locks available for extra

Finishes :

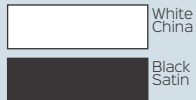

Certifications :



GO STEEL MOBILE PEDESTAL - GMP3

Specifications :

Overall Size 610H x 460W x 472D

Features :

- For larger workstations
- Lockable - Supplied with 2 keys
- Stores foolscap files back to front
- Flush drawer front
- Full extension ball bearing runners
- Fifth wheel for stability
- Keyed alike locks available for extra

Finishes :

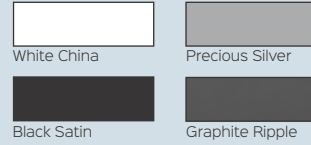

Certifications :

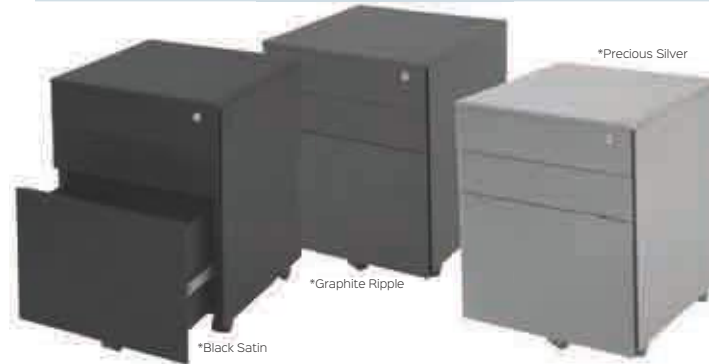

GO STEEL MOBILE CADDY - GCAD

Specifications :

Overall Size 570H x 1050W x 460D

Features :

- Full flush front
- Lockable mobile pedestal
- Tambour door section with centre shelf
- Ideal for hot desks or as desk return
- GCAD L - Tambour door on left hand side
- GCAD R - Tambour door on right hand side
- Seat pad available

Finishes :



Certifications :



ETERNITY SLIMLINE MOBILE PED - EMP3 WB

Specifications :

Overall Size 580H x 300W x 535D

Features :

- Stylish curved corners
- Slimline for smaller workstation
- Powdercoated steel mobile pedestal
- 2 personal drawers and 1 file drawer
- Fifth wheel for stability and anti-tilt
- Lockable - Supplied with 2 keys

Finishes :



Certifications :



GO STEEL FILING CABINET

Specifications :

Size 460mm W x 620mm D
Options • GFCA2 - 2 drawer, 705mm H
• GFCA3 - 3 drawer - 1016mm H
• GFCA4 - 4 drawer - 1321mm H

Features :

- Lockable - Supplied with 2 keys
- Heavy duty and Fully riveted
- Ball bearing runners
- 40kg weight capacity per drawer

Finishes :

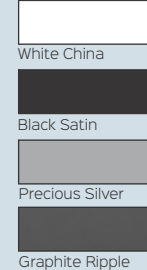

Certifications :



GO STEEL LATERAL FILING CABINET

Specifications :

Size 900mm W x 473mm D
Height • GLF2 - 2 drawer - 705mm
• GLF3 - 3 drawer - 1016mm
• GLF4 - 4 drawer - 1321mm

Features :

- Lockable - Supplied with 2 keys
- Riveted construction for extra strength
- Heavy duty and Anti-tilt
- 2 rows of folders per drawer

Finishes :



Certifications :



STEEL STORAGE

OFFICE LOCKER - OFL138 WC

Specifications :

Overall Size : 1375H x 800W x 486D

Features :

- Space efficient storage system for offices
- 6 lockable individual compartments per unit
- Removable shelf per locker
- Mail slot on each door
- Name holder fitted to each door
- 4 easy adjustable levelling feet
- Unit finished in powdercoat

Finishes :

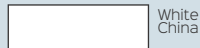

White China

Certifications :



GO STEEL CUPBOARD

Specifications :

Size : 910mm W x 450mm D
 Height : • GCA10 - 2 shelves - 1015mm
 Options : • GCA18 - 3 shelves - 1830mm
 • GCA20 - 4 shelves - 2000mm

Features :

- GO steel flush lock cupboard
- Supplied with 2 keys
- GCWSG Shelf and coat rail as optional extra for use in cupboard

Finishes :

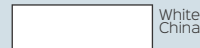

White China



Silver Grey

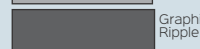

Graphite Ripple

Certifications :



TAMBOUR DOOR CUPBOARD

Specifications :

Size Options : • GTD109 - 1016H x 900W
 • GTD129 - 1200H x 900W
 • GTD199 - 1981H x 900W
 • GTD1012 - 1016H x 1200W
 • GTD1212 - 1200H x 1200W
 • GTD1912 - 1981H x 1200W
 Depth : 473mm

Features :

- Tambour door cupboards for storage
- Easy glide track
- Magnetic anti slam rail keeps doors closed
- Fully riveted for extra strength
- 40kg weight rating per shelf
- Fully Lockable with 2 keys supplies (master series)
- Adjustable feet for leveling
- Tambour door cupboard unit only, shelves sold separately
- Optional extra shelves and range of accessories available

Finishes :

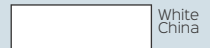

White China

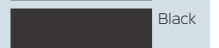

Black

Certifications :



* White China, 1981H x 1200W



* White China, 1981H x 900W



* Black, 1200H x 1200W



* White China, 1016H x 900W



SHELVING UNIT - GSC9422

Specifications :

Overall Size : 2200H x 910W x 400D

Features :

- Flat packed
- Clip together easy to assemble
- Includes 5 adjustable shelves
- In silver grey finish only
- 40kg weight rating per shelf

Finishes :

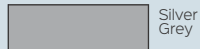

Silver Grey

Certifications :



GO STEEL WARDROBE - GWA18

Specifications :

Overall Size : 1830H x 910W x 450D

Features :

- Lockable GO steel swing door wardrobe
- Hanging rail and 3 shelves
- 4 separate storage compartments
- Fully lockable
- Supplied with 2 keys

Finishes :

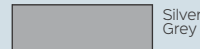

Silver Grey

Certifications :



PLANTER BOX

Specifications :

Width	• PB900 - Suits 900mm W unit
Options	• PB1200 - Suits 1200mm W unit
Size	230mm H x 473mm D

Finishes :

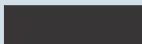
	White China
	Black

Features :

- Space for 3 x 200mm plant pots (**plants and pots not included**)
- Incorporated drip tray
- Use on top of tambour door cupboards or lateral filing cabinets

Certifications :





PLAIN SHELF

Specifications :

Width	• GTD900 - Suits 900mm W unit
Options	• GTD1200 - Suits 1200mm W unit
Size	470mm D x 30mm T

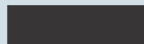
Finishes :

	White China
	Black

Features :

- Standard shelf to use with Tambour door cupboards
- Easy to install - Clips supplied
- Easy to adjust to different heights

Certifications :





PULL OUT SHELF

Specifications :

Width	GG09PS - Suits 900mm W unit
Options	GG12PS - Suits 1200mm W unit
Size	470mm D x 30mm T

Finishes :

	White China
---	-------------

Features :

- Pull out shelf for use in tambour door cupboard units
- Shelf slides out for easy operation to find or work on files

Certifications :



ROLL OUT FILING FRAME

Specifications :

Width	• GG09FF - 750mm width for 900mm wide unit - can take 1 row of foolscap folders
Options	• GG12FF - 1050mm width for 1200mm wide unit - can take 2 rows of foolscap folders

Features :

- Store foolscap folders and roll out for easy access to files

Finishes :

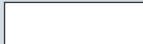
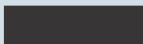
	White China
	Black

Certifications :





SLOTTED SHELF AND DIVIDERS

Specifications :

Shelf Options	• GG09SLOT - Suits 900mm W unit
	• GG12SLOT - Suits 1200mm W unit
Dividers	GS7D - pack of 5 slotted shelf dividers

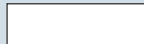
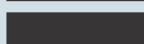
Finishes :

	White China
	Black

Certifications :



Features :

- Slotted shelf for use in tambour door cupboards
- Accepts separate slotted shelf dividers
- Rear support for dividers
- Reinforced shelf for heavy duty durability and stability
- Great for dividing documents and folders
- Holds folders vertically



MOBILE STORAGE

Space efficient method of bulk storage with base mounted false floor, easy to level with adjustable feet.

Lockable Mobile shelving unit available in 2 different widths and 4, 6 or 8 bay configuration.

Add on extra double bays or additional shelves in both widths at anytime, to extend size and storage capacity of mobile shelving unit.

White powdercoated finish to unit for modern style with charcoal grey base.



4 BAY MOBILE SHELVING

Specifications :

Width	• RMS4900 - 980mm • RMS41200 - 1280mm
Length	2670mm
Height	2150mm
Shelf Capacity	110kg per shelf

Finishes :



6 BAY MOBILE SHELVING

Specifications :

Width	• RMS6900 - 980mm • RMS61200 - 1280mm
Length	3560mm
Height	2150mm
Shelf Capacity	110kg per shelf

Finishes :



8 BAY MOBILE SHELVING

Specifications :

Width	• RMS8900 - 980mm • RMS81200 - 1280mm
Length	4450mm
Height	2150mm
Shelf Capacity	110kg per shelf

Finishes :



Melamine lockers offer a personal storage solution that blends into your space. Use in both office and educational applications. Each locker includes 2 x keys per lock.

Various internal features in each compartment. Moisture resistant melamine and MDF doors with soft close hinges, and adjustable levelling feet to each unit.

Finish Options :

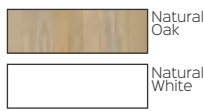

Certifications :



SINGLE LOCKER - WRML-305/1

Specifications :
 Overall Size 1850H x 305W x 455D

Features :

- MR Melamine carcass
- MDF doors
- Soft close hinges
- Adjustable leveling feet
- 1 x Hat shelf, 1 x hanging rail
- Includes 2 x keys per lock
- Digital Lock option for extra

2 DOOR LOCKER - WRML-305/2

Specifications :
 Overall Size 1850H x 305W x 455D

Features :

- MR Melamine carcass
- MDF doors
- Soft close hinges
- Adjustable leveling feet
- 1 x hanging rail per compartment
- Includes 2 x keys per lock
- Digital Lock option for extra

3 DOOR LOCKER - WRML-305/3

Specifications :
 Overall Size 1850H x 305W x 455D

Features :

- MR Melamine carcass
- MDF doors
- Soft close hinges
- Adjustable leveling feet
- 3 x Locker compartments
- Includes 2 x keys per locker
- Digital Lock option for extra

4 DOOR LOCKER - WRML-305/4

Specifications :
 Overall Size 1850H x 305W x 455D

Features :

- MR Melamine carcass
- MDF doors
- Soft close hinges
- Adjustable leveling feet
- 4 x Locker compartments
- Includes 2 x keys per locker
- Digital Lock option for extra

STEP DOOR - SDWRML380/2

Specifications :
 Overall Size 1850H x 380W x 455D

Features :

- MR Melamine carcass
- MDF doors
- Soft close hinges
- Adjustable leveling feet
- 1 x hanging rail per compartment
- Includes 2 x keys per lock
- Digital Lock option for extra



STEEL LOCKERS

Steel lockers offer an easy way to store personal belongings. Includes 2 keys supplied per locker compartment. Choose from single, 2 or 4 door options to suit your requirements, or a step locker which provides 2 hanging spaces.

Finish Options :

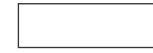

White China
(305W units only)



Silver Grey
(305W & 380W units)



SINGLE DOOR LOCKER	2 DOOR LOCKER	4 DOOR LOCKER	STEP LOCKER - GSL380														
<p>Specifications :</p> <table border="1"> <tr> <td>Width Options</td> <td>• GL305/1 - 305mm • GL380/1 - 380mm</td> </tr> <tr> <td>Size</td> <td>1830mm H x 455mm D</td> </tr> </table> <p>Features :</p> <ul style="list-style-type: none"> • Riveted construction for extra strength • Vented doors for ventilation • 1 x hat shelf, 1 x coat rail storage • Full length stiffeners fitted to each door for rigidity 	Width Options	• GL305/1 - 305mm • GL380/1 - 380mm	Size	1830mm H x 455mm D	<p>Specifications :</p> <table border="1"> <tr> <td>Width Options</td> <td>• GL305/2 - 305mm • GL380/2 - 380mm</td> </tr> <tr> <td>Size</td> <td>1830mm H x 455mm D</td> </tr> </table> <p>Features :</p> <ul style="list-style-type: none"> • Riveted construction for extra strength • Vented doors for ventilation • 1 x coat hook per compartment • Full length stiffeners fitted to each door for rigidity 	Width Options	• GL305/2 - 305mm • GL380/2 - 380mm	Size	1830mm H x 455mm D	<p>Specifications :</p> <table border="1"> <tr> <td>Width Options</td> <td>• GL305/4 - 305mm • GL380/4 - 380mm</td> </tr> <tr> <td>Size</td> <td>1830mm H x 455mm D</td> </tr> </table> <p>Features :</p> <ul style="list-style-type: none"> • Riveted construction for extra strength • Vented doors for ventilation • Full length stiffeners fitted to each door for rigidity 	Width Options	• GL305/4 - 305mm • GL380/4 - 380mm	Size	1830mm H x 455mm D	<p>Specifications :</p> <table border="1"> <tr> <td>Overall Size</td> <td>1830H x 380W x 455D</td> </tr> </table> <p>Features :</p> <ul style="list-style-type: none"> • Riveted construction for extra strength • Vented doors for ventilation • 1 x hanging rail per compartment • Full length stiffeners fitted to each door for rigidity • *Silver Grey finish only 	Overall Size	1830H x 380W x 455D
Width Options	• GL305/1 - 305mm • GL380/1 - 380mm																
Size	1830mm H x 455mm D																
Width Options	• GL305/2 - 305mm • GL380/2 - 380mm																
Size	1830mm H x 455mm D																
Width Options	• GL305/4 - 305mm • GL380/4 - 380mm																
Size	1830mm H x 455mm D																
Overall Size	1830H x 380W x 455D																



LOCKER STAND

Specifications :

Width Options	• SB2305 - 610mm W for 2 lockers • SB3305 - 915mm W for 3 lockers
Size	455mm D x 150mm H

Finishes :

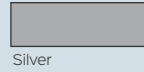

Silver

Features :

- Locker stand to bank 2 or 3 lockers
- Suitable for 305mm wide lockers only
- Silver powdercoated frame and black levelling feet
- Raise lockers off floor to allow for easy cleaning underneath and extra stability when joined together



SEAT AND STAND

Specifications :

Width Options	• S+S2305 - 610mm W for 2 lockers • S+S3305 - 915mm W for 3 lockers
Size	700mm D x 350mm H

Finishes :



Timber / Silver

Features :

- Seat and stand to suit bank of 2 or 3 lockers
- Suitable for 305mm wide lockers
- Powdercoated frame and oak style seat
- Raise lockers off floor and add a bench seat in front for use in locker rooms, schools, gyms and other applications



BENCH SEAT - BS1000

Specifications :

Overall Size	400H x 1000W x 360D
--------------	---------------------

Finishes :

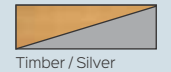

Timber / Silver

Features :

- Single sided bench seat
- Light oak style wood slats
- Silver coated frame
- Black levelling feet



SLOPING TOP

Specifications :

Width Options	• G12830 - for single 305mm W locker • G32830 - for bank of 3 x 305mm W lockers
Height	270mm



Features :

- Sloping top in silver grey
- Use with either a single locker or bank of 3 lockers
- Suitable for 305mm wide lockers only
- Neat and easy to clean 30° degree sloping top

Finishes :

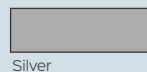

Silver



DIGITAL LOCK

Specifications :

Size	95H x 38W x 60D
Options	• DIGIPRILOCK - Private lock programming • DIGIPUBLOCK - Public lock programming



Features :

- Digital keypad code lock to be used with steel or melamine lockers as optional extra
- Public or private lock programming
- Use with both steel or melamine lockers
- *batteries not included***

Finishes :

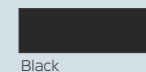

Black



BUTTERFLY LOCK - BUTTERFLY

Specifications :

Padlock Requirements	Suitable for use with padlock shafts 6mm-8mm and shackle 25mm-30mm
----------------------	--



Features :

- Butterfly lock for use with all GO Steel lockers to enable padlock facility on doors (padlock not included)
- Supplied fitted to lockers when ordered simultaneously

Finishes :

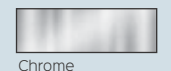

Chrome





rapidline
FURNITURE FOR TODAY